

CUT-LINE

APPLITEC

Porte-outils / Halter / Holders

H Système de serrage à bride, version courte
Spannbrücke Klemmsystem, kurze Ausführung
Independent top clamp system, short version

HX Système de serrage à bride, version longue
Spannbrücke Klemmsystem, lange Ausführung
Independent top clamp system, long version

HZ Porte-outils de grande capacité
Klemmhalter für grössere Durchmesser
High capacity tool holders

Very rigid clamping system!

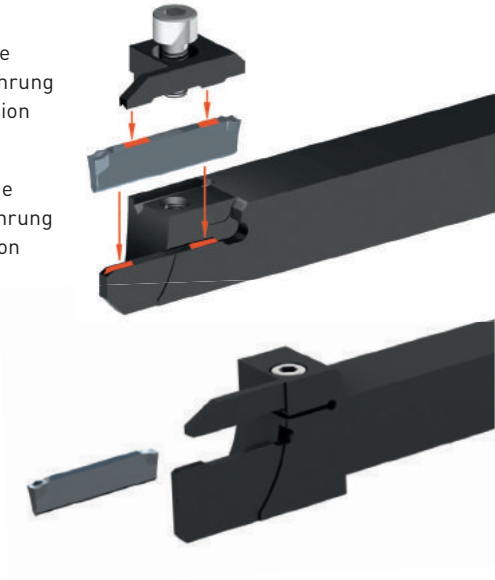

Plaquettes / WSP / Inserts

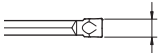
CUT 16 =  1.6 mm Ø max 20 mm

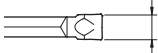
CUT 22 =  2.2 mm Ø max 42 mm

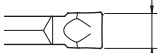
CUT 31 =  3.1 mm Ø max 65 mm

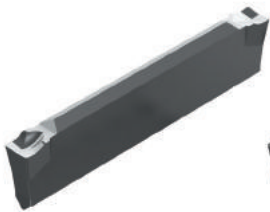

U



P



T



G

Nuances et géométries
Sorten und Geometrien
Grades and types of geometries > **9.02**

CUT 16 Ø max 20 mm > **9.04**

Paramètres de coupe indicatifs
Empfohlene Schnittwerte
Standard machining data
CUT 22 Ø max 42 mm > **9.06**

CUT 31 Ø max 65 mm > **9.08**

H Series > **9.10**

Porte-outils
Halter
Holders
HX Series > **9.11**

HZ Series > **9.12**

Porte-outils avec arrosage intégré
Halter mit integrierter Kühlmittelzufuhr
Holders with integrated coolant supply
HZ-JET Series > **9.13**

U Series > **9.14**

Plaquettes de tronçonnage
Abstechwendeplatten
Cut off inserts
P Series > **9.16**

T Series > **9.20**

Plaquettes de fonçage, tournage et tronçonnage
WSP zum einstecken, drehen und abstechen
Inserts for grooving, turning and cut off
G Series > **9.21**

Nuances

Sorten

Grades

<h2>TiAlN</h2> <p>revêtement PVD PVD Beschichtung PVD coating</p>	<h2>Tmax</h2> <p>revêtement PVD PVD Beschichtung PVD coating</p>	<h2>Zmax</h2> <p>revêtement PVD PVD Beschichtung PVD coating</p>
<ul style="list-style-type: none"> pour l'usinage des aciers, aciers inoxydables et alliages de titane 1^{er} choix pour les avances faibles à modérées 	<ul style="list-style-type: none"> nuance pour usinage moyen à lourd des aciers, aciers alliés et inoxydables bonne résistance aux températures d'usinage élevées 1^{er} choix pour le tronçonnage des aciers au carbone et des aciers fortement alliés 	<ul style="list-style-type: none"> pour l'usinage des aciers, aciers inoxydables et alliages de titane en conditions défavorables bonne résistance aux chocs à des vitesses de coupe moyenne à faible 1^{er} choix pour le tronçonnage en coupe interrompue
<ul style="list-style-type: none"> für die Bearbeitung von Stahl, rostfreiem Stahl und Titanlegierungen beste Wahl für niedrige bis mittlere Vorschübe 	<ul style="list-style-type: none"> Sorte für mittlere bis hohe Belastung in Stahl und legierter Stahlbearbeitung gute Bearbeitungswarmfestigkeit für die Bearbeitung von legiertem Kohlenstahl und hoch legiertem Stahl bestens geeignet 	<ul style="list-style-type: none"> für die Bearbeitung von Stahl, rostfreiem Stahl und Titanlegierungen in schwierige Bearbeitungsfälle gute Bruchfestigkeit mit durchschnittliche bis niedrige Schnittgeschwindigkeit für die Bearbeitung in unterbrochenen Schnitte bestens geeignet
<ul style="list-style-type: none"> for machining of steel, stainless steel and titanium alloys first choice for low to average cutting speed 	<ul style="list-style-type: none"> grade for medium to heavy machining of steel, stainless steel and alloyed steel high machining heat resistance first choice for the machining of carbon steel and high alloyed steel 	<ul style="list-style-type: none"> for machining of steel, stainless steel and titanium alloys in unfavourable machining conditions good impact resistance with average to low cutting speed first choice for machining in interrupted cut
<h2>HTA</h2> <p>revêtement PVD PVD Beschichtung PVD coating</p>	<h2>AS</h2> <p>revêtement PVD PVD Beschichtung PVD coating</p>	<h2>N</h2> <p>non revêtu unbeschichtet uncoated</p>
<ul style="list-style-type: none"> très bonne résistance à l'usure pour le tronçonnage des aciers, aciers inoxydables et alliages de titane déconseillé en coupe interrompue 	<ul style="list-style-type: none"> nuance pour métaux non ferreux très faible coefficient de frottement 1^{er} choix pour l'usinage des aluminiums jusqu'à 5% Si, des cuivres et titanes faiblement alliés 	<ul style="list-style-type: none"> nuance pour les laitons, pour la géométrie PNW et PRW
<ul style="list-style-type: none"> sehr gute Verschleissfestigkeit für die Bearbeitung von Stahl, rostfreiem Stahl und Titanlegierung bestens geeignet für unterbrochene Schnitte ungeeignet 	<ul style="list-style-type: none"> Sorte für Nichteisenmetalle sehr geringer Reibwert für die Bearbeitung von Aluminium bis 5% Si, Kupfer und niedriglegiertem Titan bestens geeignet 	<ul style="list-style-type: none"> Sorte für Messing, für PNW und PRW Geometrie
<ul style="list-style-type: none"> very good wear resistance first choice for steel, stainless steel and titanium alloys machining not suitable for interrupted cut 	<ul style="list-style-type: none"> grade for non-ferrous materials very low friction ratio first choice for Aluminium up to 5% Si, copper and low alloyed titanium 	<ul style="list-style-type: none"> grade for brass, for PNW and PRW geometry

Géométries de coupe

Spanformgeometrie

Cutting geometries

UN

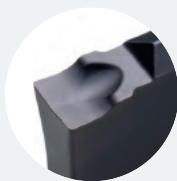
UR
UL

- géométrie positive universelle, bonne maîtrise du copeau
- allgemeine Geometrie, sehr gute Spankontrolle
- all-round insert with efficient chip control

PN

PR

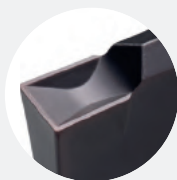

- géométrie légèrement positive pour les aciers, aciers au carbone, aciers alliés
- leicht positive Geometrie für Stahl, Kohlenstoffstahl, legiertem Stahl
- slightly positive geometry for steel, carbon steel, alloyed steel

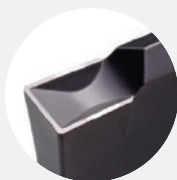
PNW
PRW

- géométrie neutre pour les laitons
- neutrale Geometrie für Messing
- neutral geometry for brasses

TN



- géométrie négative pour de fortes avances dans des conditions de rigidité favorable
- negative Geometrie für hohe Vorschübe in guten Stabilitätsfällen
- negative geometry for high feed rate in case of good stability

GN



- géométrie universelle pour fonçage-tournage, peut également être utilisée en tronçonnage
- allgemeine Geometrie zum einstecken-langdrehen, kann auch zum abstechen verwendet werden
- all-round insert for grooving and turning, can also be used for parting off







CUT-LINE

Paramètres de coupe indicatifs

Empfohlene Schnittwerte

Standard machining data

CUT 16

		P Acier Stahl Steel						M Inox Rostfreistahl Stainless steel		
		Acier de décolletage Automatenstahl Free-cutting steel		Acier faiblement allié Leicht legierter Stahl Low alloyed steel		Acier fortement allié Legierter Stahl High alloyed steel		Austénitique et martensitique Austenitisch und martensitisch Austenitic and martensitic		
		VC (m/min)	F (mm/U)	VC (m/min)	F (mm/U)	VC (m/min)	F (mm/U)	VC (m/min)	F (mm/U)	
Avance standard Standard Vorschub Standard feed rate	CUT16-UN-001 	TiAlN	90-140	0.03-0.07	60-120	0.03-0.07	50-100	0.04-0.08	50-120	0.03-0.07
		Tmax	100-170	0.03-0.07	70-150	0.03-0.07	60-120	0.04-0.08	60-150	0.03-0.07
		Zmax	80-130*	0.04-0.10	50-110*	0.04-0.10	50-90*	0.04-0.08	50-120*	0.04-0.10
		HTA	70-120	0.03-0.05	60-100	0.03-0.05	50-90	0.03-0.05	50-100	0.03-0.06
		AS								
	CUT16-PR-801 	TiAlN	90-140	0.03-0.07	60-120	0.03-0.07	50-100	0.03-0.07	50-120	0.03-0.07
	Tmax	100-170	0.03-0.07	70-150	0.03-0.07	60-120	0.03-0.07	60-150	0.03-0.07	
CUT16-PRW-801 	N									
Avance modérée Niedriger Vorschub Low feed rate	CUT16-UN-000F 	TiAlN	80-130	0.02-0.05	50-110	0.02-0.05	50-90	0.02-0.05	50-80	0.02-0.05
		HTA	60-100	0.01-0.04	50-90	0.01-0.04	50-80	0.02-0.05	50-80	0.02-0.05
		AS								
	CUT16-UL/R-800F 	TiAlN	80-130	0.02-0.05	50-110	0.02-0.05	50-90	0.02-0.05	50-80	0.02-0.05
		HTA	60-100	0.01-0.04	50-90	0.01-0.04	50-80	0.02-0.05	50-80	0.02-0.05
		AS								
	CUT16-UL/R-1500F 	TiAlN	80-130	0.02-0.05	50-110	0.02-0.05	50-90	0.02-0.05	50-80	0.02-0.05
		HTA	60-100	0.01-0.04	50-90	0.01-0.04	50-80	0.02-0.05	50-80	0.02-0.05
		AS								

** arête de coupe vive

** scharfe Schneidkante

** sharp cutting edge

N Alliage d'aluminium et non ferreux Aluminium- und Nichteisenlegierungen Aluminium and non-ferrous alloys								S Titane Titan Titanium			
Aluminium		Alu silicium max. 5% Aluminiumsilicium max. 5% Aluminium silicon max. 5%		Cuivre Kupfer Copper		Laiton & bronze Messing & Bronze Brass & bronze		Gr. 1 - 3		Gr. 4 - 5	
VC (m/min)	F (mm/U)	VC (m/min)	F (mm/U)	VC (m/min)	F (mm/U)	VC (m/min)	F (mm/U)	VC (m/min)	F (mm/U)	VC (m/min)	F (mm/U)
100-250	0.03-0.10	100-250	0.03-0.10	100-300	0.03-0.10	100-300	0.03-0.10			30-60	0.04-0.08
100-300	0.04-0.10	100-250	0.04-0.10	100-300	0.03-0.08	150-300	0.03-0.08			30-60	0.04-0.08
150-300	0.04-0.15	100-300	0.04-0.10	100-300	0.04-0.10	150-300	0.02-0.08	30-60	0.04-0.08	30-60	0.04-0.08
						150-300	0.03-0.10				
						100-500	0.02-0.10				
100-300	0.02-0.05	100-250	0.01-0.04	100-250	0.01-0.04	100-300	0.02-0.05			30-60	0.01-0.04
100-300	0.02-0.05	100-250	0.02-0.05	100-250	0.02-0.05	100-300	0.02-0.05			30-60	0.02-0.06
100-300	0.02-0.05	100-250	0.02-0.05	100-250	0.02-0.05	100-300	0.02-0.05	30-60	0.02-0.06	30-60	0.02-0.06
100-300	0.02-0.05	100-250	0.01-0.04	100-250	0.01-0.04	100-300	0.02-0.05			30-60	0.01-0.04
100-300	0.02-0.05	100-250	0.02-0.05	100-250	0.02-0.05	100-300	0.02-0.05			30-60	0.02-0.06
100-300	0.02-0.05	100-250	0.02-0.05	100-250	0.02-0.05	100-300	0.02-0.05	30-60	0.02-0.06	30-60	0.02-0.06
100-300	0.02-0.05	100-250	0.01-0.04	100-250	0.01-0.04	100-300	0.02-0.05			30-60	0.01-0.04
100-300	0.02-0.05	100-250	0.02-0.05	100-250	0.02-0.05	100-300	0.02-0.05			30-60	0.02-0.06
100-300	0.02-0.05	100-250	0.02-0.05	100-250	0.02-0.05	100-300	0.02-0.05	30-60	0.02-0.06	30-60	0.02-0.06









CUT-LINE

Paramètres de coupe indicatifs

Empfohlene Schnittwerte

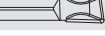
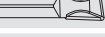
Standard machining data

CUT 22

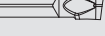
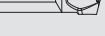
			P Acier Stahl Steel						M Inox Rostfreistahl Stainless steel	
			Acier de décolletage Automatenstahl Free-cutting steel		Acier faiblement allié Leicht legierter Stahl Low alloyed steel		Acier fortement allié Legierter Stahl High alloyed steel		Austénitique et martensitique Austenitisch und martensitisch Austenitic and martensitic	
			VC (m/min)	F (mm/U)	VC (m/min)	F (mm/U)	VC (m/min)	F (mm/U)	VC (m/min)	F (mm/U)
Avance standard Standard Vorschub Standard feed rate	CUT22-UN-002 CUT22-UR-802 	TiAlN	90-140	0.04-0.08	60-120	0.04-0.08	50-100	0.04-0.08	50-120	0.04-0.08
		Tmax	100-170	0.04-0.08	70-150	0.04-0.08	60-120	0.04-0.08	60-150	0.04-0.08
		Zmax	80-130*	0.04-0.10	50-110*	0.04-0.10	50-90*	0.04-0.08	50-120*	0.04-0.10
		HTA	70-120	0.04-0.06	60-100	0.04-0.06	50-90	0.04-0.06	50-100	0.04-0.06
		AS								
	CUT22-PN-002 	TiAlN	90-140	0.04-0.10	60-120	0.04-0.08	50-100	0.04-0.08		
	Tmax	100-170	0.04-0.10	70-150	0.04-0.10	60-120	0.04-0.10			
	CUT22-PNW-002 	N								
	CUT22-PR-002 	TiAlN	90-140	0.04-0.08	60-120	0.04-0.08	50-100	0.04-0.08	50-120	0.04-0.08
	Tmax	100-170	0.04-0.08	70-150	0.04-0.08	60-120	0.04-0.08	60-150	0.04-0.08	
CUT22-PRW-002 	N									
CUT22-TN-002 	TiAlN	90-140	0.08-0.18	60-120	0.08-0.18	50-100	0.08-0.15	50-120	0.08-0.20	
Tmax	100-170	0.08-0.18	70-150	0.08-0.18	60-120	0.08-0.15	60-150	0.08-0.20		
Zmax	80-130*	0.08-0.18	50-110*	0.08-0.18	50-90*	0.08-0.15				
CUT22-GN-002 *** 	TiAlN	90-140	0.03-0.12	60-120	0.03-0.12	50-100	0.03-0.10	50-120	0.03-0.08	
Tmax	100-170	0.03-0.12	70-150	0.03-0.12	60-120	0.03-0.10	70-120	0.03-0.08		
AS										
Avance modérée Niedriger Vorschub Low feed rate	CUT22-UN-000F 	TiAlN	80-130	0.02-0.05	50-110	0.02-0.05	50-90	0.02-0.05	50-80	0.02-0.05
		HTA	60-100	0.01-0.04	50-90	0.01-0.04	50-80	0.02-0.05	50-80	0.02-0.05
		AS								
	CUT22-UL/R-800F 	TiAlN	80-130	0.02-0.05	50-110	0.02-0.05	50-90	0.02-0.05	50-80	0.02-0.05
		HTA	60-100	0.01-0.04	50-90	0.01-0.04	50-80	0.02-0.05	50-80	0.02-0.05
		AS								
	CUT22-UL/R-802F 	TiAlN	80-130	0.02-0.05	50-110	0.02-0.05	50-90	0.02-0.05	50-80	0.02-0.05
		HTA	60-100	0.01-0.04	50-90	0.01-0.04	50-80	0.02-0.05	50-80	0.02-0.05
		AS								
	CUT22-UL/R-1500F 	TiAlN	80-130	0.02-0.05	50-110	0.02-0.05	50-90	0.02-0.05	50-80	0.02-0.05
		HTA	60-100	0.01-0.04	50-90	0.01-0.04	50-80	0.02-0.05	50-80	0.02-0.05
		AS								

* premier choix en cas de coupe interrompue

** arête de coupe vive

*** géométrie fonçage-tournage (évent. tronçonnage)

* beste Basis für unterbrochene Schnitte

** scharfe Schneidkante

*** Geometrie zum einstechen und drehen (event. abstechen)

* first choice for interrupted cut

** sharp cutting edge

*** geometry for grooving and turning (event. parting off)

N Allages d'aluminium et non ferreux Aluminium- und Nichteisenlegierungen Aluminium and non-ferrous alloys								S Titane Titan Titanium			
Aluminium		Alu silicium max. 5% Aluminiumsilicium max. 5% Aluminium silicium max. 5%		Cuivre Kupfer Copper		Laiton & bronze Messing & Bronze Brass & bronze		Gr. 1 - 3		Gr. 4 - 5	
VC (m/min)	F (mm/U)	VC (m/min)	F (mm/U)	VC (m/min)	F (mm/U)	VC (m/min)	F (mm/U)	VC (m/min)	F (mm/U)	VC (m/min)	F (mm/U)
100-250	0.03-0.10	100-250	0.03-0.10	100-300	0.03-0.10	100-300	0.03-0.10			30-60	0.04-0.08
100-300	0.04-0.10	100-250	0.04-0.10	100-300	0.03-0.08	150-300	0.03-0.08			30-60	0.04-0.08
150-300	0.04-0.15	100-300	0.04-0.10	100-300	0.04-0.10	150-300	0.02-0.08	30-60	0.04-0.08	30-60	0.04-0.08
						150-300	0.03-0.10				
						100-500	0.02-0.10				
						150-300	0.03-0.10				
						100-500	0.02-0.10				
						150-300	0.05-0.20				
100-300	0.03-0.12	100-200	0.03-0.10	100-200	0.03-0.10	100-300	0.03-0.12			30-60	0.04-0.08
						100-300	0.03-0.12				
100-300	0.03-0.12	100-200	0.03-0.10	100-200	0.03-0.10	100-300	0.03-0.12	30-60	0.04-0.08	30-60	0.04-0.08
100-300	0.02-0.05	100-250	0.01-0.04	100-250	0.01-0.04	100-300	0.02-0.05			30-60	0.01-0.04
100-300	0.02-0.05	100-250	0.02-0.05	100-250	0.02-0.05	100-300	0.02-0.05			30-60	0.02-0.06
100-300	0.02-0.05	100-250	0.02-0.05	100-250	0.02-0.05	100-300	0.02-0.05	30-60	0.02-0.06	30-60	0.02-0.06
100-300	0.02-0.05	100-250	0.01-0.04	100-250	0.01-0.04	100-300	0.02-0.05			30-60	0.01-0.04
100-300	0.02-0.05	100-250	0.02-0.05	100-250	0.02-0.05	100-300	0.02-0.05			30-60	0.02-0.06
100-300	0.02-0.05	100-250	0.02-0.05	100-250	0.02-0.05	100-300	0.02-0.05	30-60	0.02-0.06	30-60	0.02-0.06
100-300	0.02-0.05	100-250	0.01-0.04	100-250	0.01-0.04	100-300	0.02-0.05			30-60	0.01-0.04
100-300	0.02-0.05	100-250	0.02-0.05	100-250	0.02-0.05	100-300	0.02-0.05			30-60	0.02-0.06
100-300	0.02-0.05	100-250	0.02-0.05	100-250	0.02-0.05	100-300	0.02-0.05	30-60	0.02-0.06	30-60	0.02-0.06
100-300	0.02-0.05	100-250	0.01-0.04	100-250	0.01-0.04	100-300	0.02-0.05			30-60	0.01-0.04
100-300	0.02-0.05	100-250	0.02-0.05	100-250	0.02-0.05	100-300	0.02-0.05			30-60	0.02-0.06
100-300	0.02-0.05	100-250	0.02-0.05	100-250	0.02-0.05	100-300	0.02-0.05	30-60	0.02-0.06	30-60	0.02-0.06









CUT-LINE

Paramètres de coupe indicatifs

Empfohlene Schnittwerte

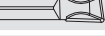
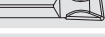
Standard machining data

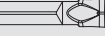
CUT 31

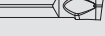
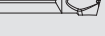
		P Acier Stahl Steel						M Inox Rostfreistahl Stainless steel		
		Acier de décolletage Automatenstahl Free-cutting steel		Acier faiblement allié Leicht legierter Stahl Low alloyed steel		Acier fortement allié Legierter Stahl High alloyed steel		Austénitique et martensitique Austenitisch und martensitisch Austenitic and martensitic		
		VC (m/min)	F (mm/U)	VC (m/min)	F (mm/U)	VC (m/min)	F (mm/U)	VC (m/min)	F (mm/U)	
Avance standard Standard Vorschub Standard feed rate	CUT31-UN-002 	TiAlN	90-140	0.04-0.08	60-120	0.04-0.08	50-100	0.04-0.08	50-120	0.04-0.10
		Tmax	100-170	0.04-0.08	70-150	0.04-0.08	60-120	0.04-0.08	60-150	0.04-0.10
		Zmax	80-130*	0.04-0.10	50-110*	0.04-0.10	50-90*	0.04-0.08	50-120*	0.04-0.10
		HTA	70-120	0.04-0.06	60-100	0.04-0.06	50-90	0.04-0.06	50-100	0.04-0.06
		AS								
	CUT31-PN-002 	TiAlN	90-140	0.04-0.10	60-120	0.04-0.08	50-100	0.04-0.08		
		Tmax	100-170	0.04-0.10	70-150	0.04-0.10	60-120	0.04-0.10		
	CUT31-PNW-002 	N								
	CUT31-PR-802 	TiAlN	90-140	0.04-0.08	60-120	0.04-0.08	50-100	0.04-0.08	50-120	0.04-0.08
		Tmax	100-170	0.04-0.08	70-150	0.04-0.08	60-120	0.04-0.08	60-150	0.04-0.08
CUT31-PRW-802 	N									
CUT31-TN-002 	TiAlN	90-140	0.08-0.20	60-120	0.08-0.20	50-100	0.08-0.15	50-120	0.08-0.20	
	Tmax	100-170	0.08-0.20	70-150	0.08-0.20	60-120	0.08-0.15	60-150	0.08-0.20	
	Zmax	80-130*	0.08-0.20	50-110*	0.08-0.20	50-90*	0.08-0.15			
CUT31-GN-002 *** 	TiAlN	90-140	0.04-0.15	60-120	0.04-0.15	50-100	0.04-0.10	50-120	0.04-0.10	
	Tmax	100-170	0.04-0.15	70-150	0.04-0.15	60-120	0.04-0.10	70-120	0.04-0.10	
	AS									
Avance modérée Niedriger Vorschub Low feed rate	CUT31-UN-000F 	TiAlN	80-130	0.02-0.05	50-110	0.02-0.05	50-90	0.02-0.05	50-80	0.02-0.05
		HTA	60-100	0.01-0.04	50-90	0.01-0.04	50-80	0.02-0.05	50-80	0.02-0.05
		AS								
	CUT31-UL/R-800F 	TiAlN	80-130	0.02-0.05	50-110	0.02-0.05	50-90	0.02-0.05	50-80	0.02-0.05
		HTA	60-100	0.01-0.04	50-90	0.01-0.04	50-80	0.02-0.05	50-80	0.02-0.05
		AS								
	CUT31-UL/R-802F 	TiAlN	80-130	0.02-0.05	50-110	0.02-0.05	50-90	0.02-0.05	50-80	0.02-0.05
		HTA	60-100	0.01-0.04	50-90	0.01-0.04	50-80	0.02-0.05	50-80	0.02-0.05
		AS								
	CUT31-UL/R-1500F 	TiAlN	80-130	0.02-0.05	50-110	0.02-0.05	50-90	0.02-0.05	50-80	0.02-0.05
		HTA	60-100	0.01-0.04	50-90	0.01-0.04	50-80	0.02-0.05	50-80	0.02-0.05
		AS								

* premier choix en cas de coupe interrompue

** arête de coupe vive

*** géométrie fonçage-tournage (évent. tronçonnage)

* beste Basis für unterbrochene Schnitte

** scharfe Schneidkante

*** Geometrie zum einstechen und drehen (event. abstechen)

* first choice for interrupted cut

** sharp cutting edge

*** geometry for grooving and turning (event. parting off)

N Allages d'aluminium et non ferreux Aluminium- und Nichteisenlegierungen Aluminium and non-ferrous alloys								S Titane Titan Titanium			
Aluminium		Alu silicium max. 5% Aluminiumsilicium max. 5% Aluminium silicium max. 5%		Cuivre Kupfer Copper		Laiton & bronze Messing & Bronze Brass & Bronze		Gr. 1 - 3		Gr. 4 - 5	
VC (m/min)	F (mm/U)	VC (m/min)	F (mm/U)	VC (m/min)	F (mm/U)	VC (m/min)	F (mm/U)	VC (m/min)	F (mm/U)	VC (m/min)	F (mm/U)
100-250	0.03-0.10	100-250	0.03-0.10	100-300	0.03-0.10	100-300	0.03-0.10			30-60	0.04-0.08
100-300	0.04-0.10	100-250	0.04-0.10	100-300	0.03-0.08	150-300	0.03-0.08			30-60	0.04-0.08
150-300	0.04-0.15	100-300	0.04-0.10	100-300	0.04-0.10	150-300	0.02-0.08	30-60	0.04-0.08	30-60	0.04-0.08
						150-300	0.03-0.10				
						100-500	0.02-0.15				
						150-300	0.03-0.10				
						100-500	0.02-0.15				
						150-300	0.05-0.20				
100-300	0.04-0.15	100-200	0.04-0.10	100-200	0.04-0.10	100-300	0.04-0.15			30-60	0.04-0.08
						100-300	0.04-0.15				
100-300	0.04-0.15	100-200	0.04-0.10	100-200	0.04-0.10	100-300	0.04-0.15	30-60	0.04-0.08	30-60	0.04-0.08
100-300	0.02-0.05	100-250	0.01-0.04	100-250	0.01-0.04	100-300	0.02-0.05			30-60	0.01-0.04
100-300	0.02-0.05	100-250	0.02-0.05	100-250	0.02-0.05	100-300	0.02-0.05			30-60	0.02-0.06
100-300	0.02-0.05	100-250	0.02-0.05	100-250	0.02-0.05	100-300	0.02-0.05	30-60	0.02-0.06	30-60	0.02-0.06
100-300	0.02-0.05	100-250	0.01-0.04	100-250	0.01-0.04	100-300	0.02-0.05			30-60	0.01-0.04
100-300	0.02-0.05	100-250	0.02-0.05	100-250	0.02-0.05	100-300	0.02-0.05			30-60	0.02-0.06
100-300	0.02-0.05	100-250	0.02-0.05	100-250	0.02-0.05	100-300	0.02-0.05	30-60	0.02-0.06	30-60	0.02-0.06
100-300	0.02-0.05	100-250	0.01-0.04	100-250	0.01-0.04	100-300	0.02-0.05			30-60	0.01-0.04
100-300	0.02-0.05	100-250	0.02-0.05	100-250	0.02-0.05	100-300	0.02-0.05			30-60	0.02-0.06
100-300	0.02-0.05	100-250	0.02-0.05	100-250	0.02-0.05	100-300	0.02-0.05	30-60	0.02-0.06	30-60	0.02-0.06
100-300	0.02-0.05	100-250	0.01-0.04	100-250	0.01-0.04	100-300	0.02-0.05			30-60	0.01-0.04
100-300	0.02-0.05	100-250	0.02-0.05	100-250	0.02-0.05	100-300	0.02-0.05			30-60	0.02-0.06
100-300	0.02-0.05	100-250	0.02-0.05	100-250	0.02-0.05	100-300	0.02-0.05	30-60	0.02-0.06	30-60	0.02-0.06



CUT-LINE

Porte-outils

Halter

Holders

Ø max 34 mm

H Series

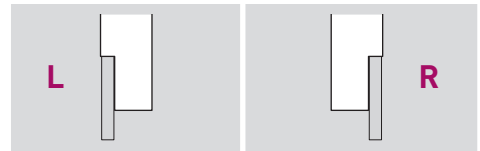
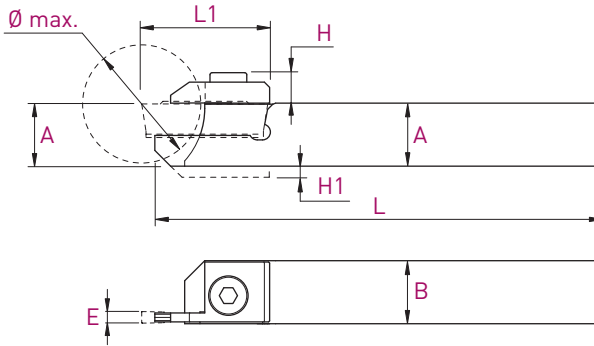

Plaquettes WSP Inserts	A x B	L	Ø max.	L1	H	H1	Art. N°	Art. N°
E 1.6 mm Type CUT16	8 x 10	115	16	19.5	6.2	2	CUT16-H0810L	CUT16-H0810R
	10 x 10	115	16	19.5	6.2	-	CUT16-H1010L	CUT16-H1010R
	12 x 12	130	16	19.5	6.2	-	CUT16-H1212L	CUT16-H1212R
	12 x 12	90	16	19.5	6.2	-	CUT16-H1212L-90	CUT16-H1212R-90
	12.7 x 12.7	130	16	19.5	6.2	-	CUT16-H127127L	CUT16-H127127R
	16 x 16	130	16	19.5	6.2	-	CUT16-H1616L	CUT16-H1616R
20 x 20	120	16	19.5	6.2	-	CUT16-H2020L	CUT16-H2020R	
E 2.2 mm Type CUT22	10 x 12	115	20	24	6.4	-	CUT22-H1012L	CUT22-H1012R
	12 x 12	130	20	24	6.4	-	CUT22-H1212L	CUT22-H1212R
	12 x 12	90	20	24	6.4	-	CUT22-H1212L-90	CUT22-H1212R-90
	12.7 x 12.7	130	20	24	6.4	-	CUT22-H127127L	CUT22-H127127R
	16 x 16	130	20	24	6.4	-	CUT22-H1616L	CUT22-H1616R
	20 x 20	120	20	24	6.4	-	CUT22-H2020L	CUT22-H2020R
E 3.1 mm Type CUT31	16 x 16	130	34	35	7.8	-	CUT31-H1616L	CUT31-H1616R
	20 x 20	120	34	35	7.8	-	CUT31-H2020L	CUT31-H2020R
	25 x 25	140	34	35	7.8	-	CUT31-H2525L	CUT31-H2525R

Pièces de rechange Ersatzteile Spare parts	L	R	Serrage Anzug Torque	
	Art. N°	Art. N°		Art. N°
CUT 16	CUT16L-SET	CUT16R-SET	V-M4X10-BN7	3.5 Nm
CUT 22	CUT22L-SET	CUT22R-SET	V-M4X10-BN7	3.5 Nm
CUT 31	CUT31L-SET	CUT31R-SET	V-M5X10-BN7	4.5 Nm

Porte-outils

Halter

Holders

Ø max 42 mm

HX Series

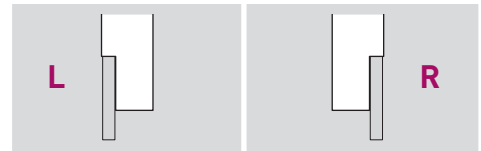
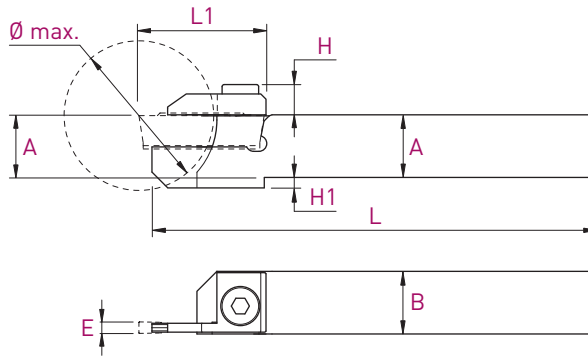

Plaquettes WSP Inserts	A x B	L	Ø max.	L1	H	H1	Art. N°	Art. N°
E 1.6 mm Type CUT16	10 x 12	115	20	21	6.2	2	CUT16-H1012LX	CUT16-H1012RX
	12 x 12	130	20	21	6.2	-	CUT16-H1212LX	CUT16-H1212RX
	12 x 12	90	20	21	6.2	-	CUT16-H1212LX-90	CUT16-H1212RX-90
	12.7 x 12.7	130	20	21	6.2	-	CUT16-H127127LX	CUT16-H127127RX
	16 x 16	130	20	21	6.2	-	CUT16-H1616LX	CUT16-H1616RX
	20 x 20	120	20	21	6.2	-	CUT16-H2020LX	CUT16-H2020RX
E 2.2 mm Type CUT22	10 x 12	115	26	25	6.4	4	CUT22-H1012LX	CUT22-H1012RX
	12 x 12	130	26	25	6.4	2	CUT22-H1212LX	CUT22-H1212RX
	12 x 12	90	26	25	6.4	2	CUT22-H1212LX-90	CUT22-H1212RX-90
	12.7 x 12.7	130	26	25	6.4	-	CUT22-H127127LX	CUT22-H127127RX
	16 x 16	130	26	25	6.4	-	CUT22-H1616LX	CUT22-H1616RX
	20 x 20	120	26	25	6.4	-	CUT22-H2020LX	CUT22-H2020RX
E 3.1 mm Type CUT31	16 x 16	120	42	37	7.8	4	CUT31-H1616LX	CUT31-H1616RX
	20 x 20	120	42	37	7.8	-	CUT31-H2020LX	CUT31-H2020RX
	25 x 25	140	42	37	7.8	-	CUT31-H2525LX	CUT31-H2525RX

Pièces de rechange Ersatzteile Spare parts	L	R		Serrage Anzug Torque
	Art. N°	Art. N°	Art. N°	
CUT 16	CUT16LX-SET	CUT16RX-SET	V-M4X10-BN7	3.5 Nm
CUT 22	CUT22LX-SET	CUT22RX-SET	V-M4X10-BN7	3.5 Nm
CUT 31	CUT31LX-SET	CUT31RX-SET	V-M5X10-BN7	4.5 Nm

CUT-LINE

Porte-outils

Halter

Holders

Ø max 65 mm

HZ Series

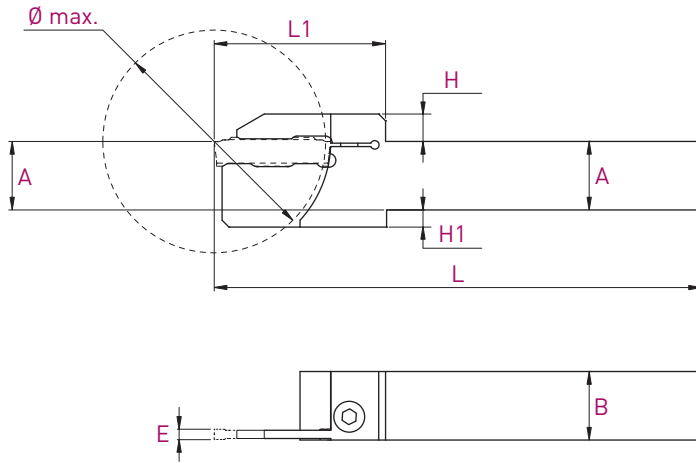

Plaquettes WSP Inserts	A x B	L	Ø max.	L1	H	H1	Art. N°	Art. N°
E 2.2 mm	16 x 16	130	32	30	7	-	CUT22-H1616LZ-D32	CUT22-H1616RZ-D32
	20 x 20	130	32	30	7	-	CUT22-H2020LZ-D32	CUT22-H2020RZ-D32
Type CUT22	16 x 16	130	42	35	7	4	CUT22-H1616LZ-D42	CUT22-H1616RZ-D42
	20 x 20	130	42	35	7	-	CUT22-H2020LZ-D42	CUT22-H2020RZ-D42
E 3.1 mm	20 x 20	140	52	44	8	5	CUT31-H2020LZ-D52	CUT31-H2020RZ-D52
	25 x 25	140	52	44	8	-	CUT31-H2525LZ-D52	CUT31-H2525RZ-D52
Type CUT31	20 x 20	140	65	50	8	5	CUT31-H2020LZ-D65	CUT31-H2020RZ-D65
	25 x 25	140	65	50	8	-	CUT31-H2525LZ-D65	CUT31-H2525RZ-D65

Pièces de rechange Ersatzteile Spare parts		Serrage Anzug Torque
	Art. N°	
CUT 22	V-M4X10-BN7	3.5 Nm
CUT 31	V-M5X10-BN7	4.5 Nm

Porte-outils avec arrosage intégré
 Halter mit integrierter Kühlmittelzufuhr
 Holders with integrated coolant supply

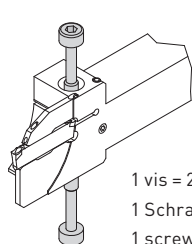
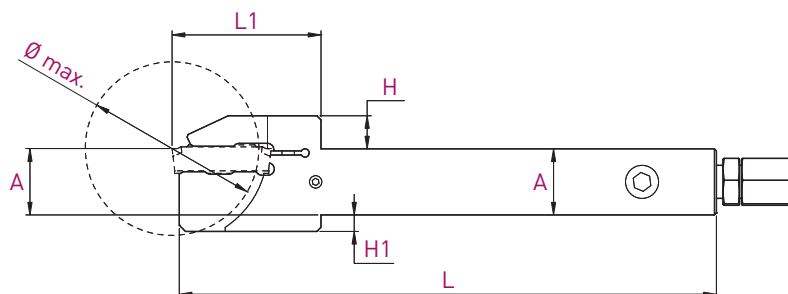

HZ-JET Series

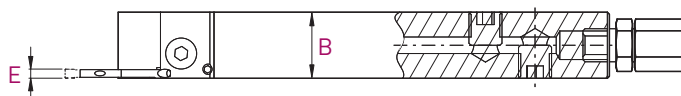

1 vis = 2 possibilités de serrage
 1 Schraube = 2 Spannmöglichkeiten
 1 screw = 2 clamp possibilities

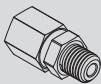

Plaquettes WSP Inserts	A x B	L	Ø max.	L1	H	H1	Art. N°	Art. N°
E 2.2 mm	16 x 16	130	42	36	8	4	CUT22-H1616LZ-JET42	CUT22-H1616RZ-JET42
Type CUT22	20 x 20	130	42	36	8	-	CUT22-H2020LZ-JET42	CUT22-H2020RZ-JET42
E 3.1 mm	16 x 16	140	65	49	9	9	CUT31-H1616LZ-JET65	CUT31-H1616RZ-JET65
Type CUT31	20 x 20	140	65	51	9	5	CUT31-H2020LZ-JET65	CUT31-H2020RZ-JET65
	25 x 25	140	65	51	9	-	CUT31-H2525LZ-JET65	CUT31-H2525RZ-JET65

Pièces de rechange Ersatzteile Spare parts		Serrage Anzug Torque		
	Art. N°		Art. N°	Art. N°
CUT 22	V-M4X22-CUT	3.5 Nm	J-M8X1-D6	JB-M8X1
CUT 31	V-M5X25-CUT	4.5 Nm	J-M8X1-D6	JB-M8X1

CUT-LINE

Plaquettes de tronçonnage
 Abstechwendeplatten
 Cut off inserts

UN Series

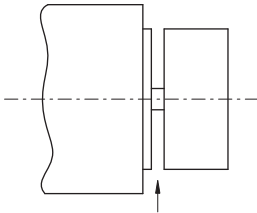
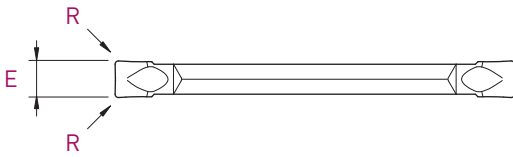
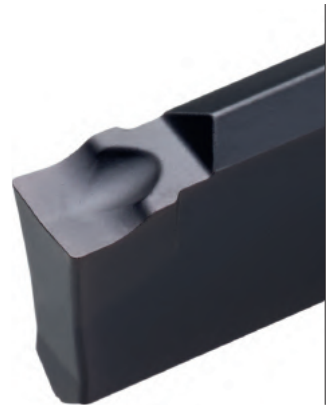
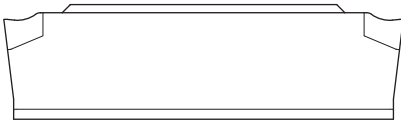

Type	E \pm 0.1	R	Art. N°	TiAIN	Tmax	Zmax	HTA	AS
CUT16	1.6	0.02	CUT16-UN-000F	■			■	■
	1.6	0.10	CUT16-UN-001	■	■	■	■	■
CUT22	2.2	0.02	CUT22-UN-000F	■			■	■
	2.2	0.20	CUT22-UN-002	■	■	■	■	■
CUT31	3.1	0.02	CUT31-UN-000F	■			■	■
	3.1	0.20	CUT31-UN-002	■	■	■	■	■

Plaquettes de tronçonnage

Abstechwendeplatten

Cut off inserts

UL-UR Series

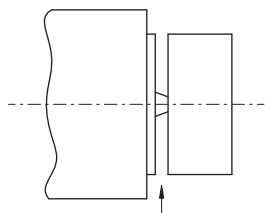
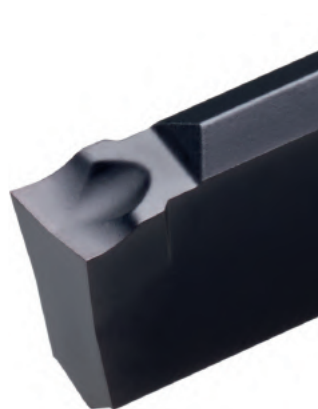
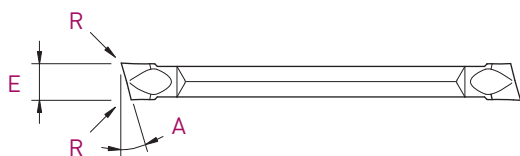
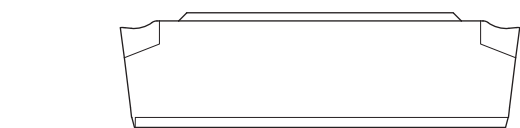

				UL			UR						
Type	E ±0.1	A	R	Art. N°	TiAlN	HTA	AS	Art. N°	TiAlN	Tmax	Zmax	HTA	AS
CUT16	1.6	8°	0.02	CUT16-UL-800F	■	■	■	CUT16-UR-800F	■			■	■
	1.6	15°	0.02	CUT16-UL-1500F	■	■	■	CUT16-UR-1500F	■			■	■
CUT22	2.2	8°	0.02	CUT22-UL-800F	■	■	■	CUT22-UR-800F	■			■	■
	2.2	8°	0.20	-				CUT22-UR-802		■	■		
	2.2	8°	0.20	CUT22-UL-802F	■	■	■	CUT22-UR-802F	■			■	■
	2.2	15°	0.02	CUT22-UL-1500F	■	■	■	CUT22-UR-1500F	■			■	■
CUT31	3.1	8°	0.02	CUT31-UL-800F	■	■	■	CUT31-UR-800F	■			■	■
	3.1	8°	0.20	CUT31-UL-802F	■	■	■	CUT31-UR-802F	■			■	■
	3.1	15°	0.02	CUT31-UL-1500F	■	■	■	CUT31-UR-1500F	■			■	■

CUT-LINE

Plaquettes de tronçonnage

Abstechwendeplatten

Cut off inserts

PN Series

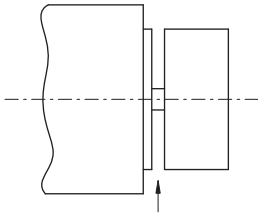
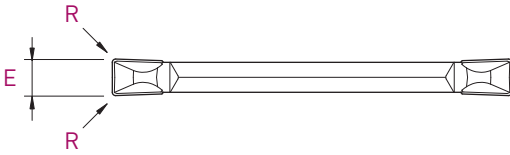
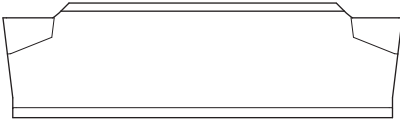

Type	E ±0.1	R	Art. N°	Trial	Tmax
CUT22	2.2	0.20	CUT22-PN-002	■	■
CUT31	3.1	0.20	CUT31-PN-002	■	■

Plaquettes de tronçonnage

Abstechwendeplatten

Cut off inserts

PR Series

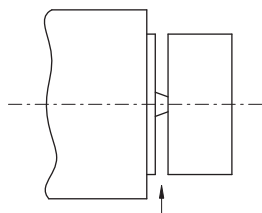
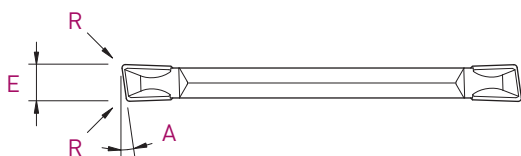
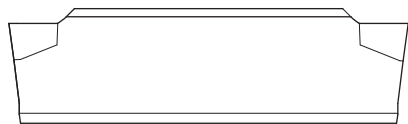

Type	E ±0.1	A	R	Art. N°	TiAlN	Tmax
CUT16	1.6	8°	0.10	CUT16-PR-801	■	■
CUT22	2.2	8°	0.20	CUT22-PR-802	■	■
CUT31	3.1	8°	0.20	CUT31-PR-802	■	■

CUT-LINE

Plaquettes de tronçonnage

Abstechwendeplatten

Cut off inserts

PNW Series

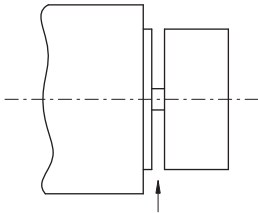
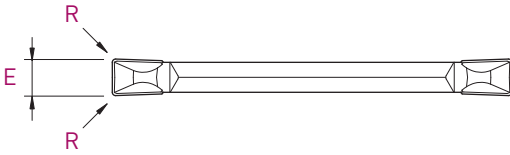
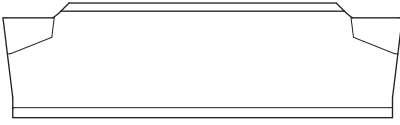

Type	E ± 0.1	R	Art. N°	Z
CUT22	2.2	0.20	CUT22-PNW-002	■
CUT31	3.1	0.20	CUT31-PNW-002	■

Plaquettes de tronçonnage

Abstechwendeplatten

Cut off inserts

PRW Series

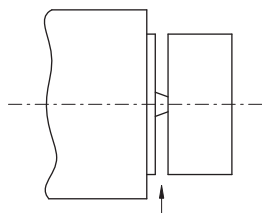
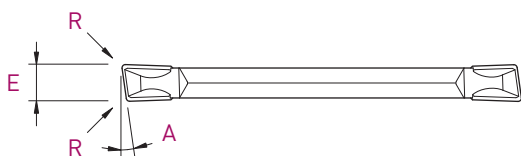
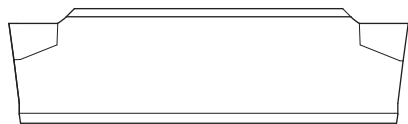

PRW



Type	E ±0.1	A	R	Art. N°	z
CUT16	1.6	8°	0.10	CUT16-PRW-801	■
CUT22	2.2	8°	0.20	CUT22-PRW-802	■
CUT31	3.1	8°	0.20	CUT31-PRW-802	■

CUT-LINE

Plaquettes de tronçonnage
 Abstechwendeplatten
 Cut off inserts

Negative geometry

TN Series

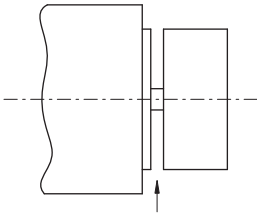
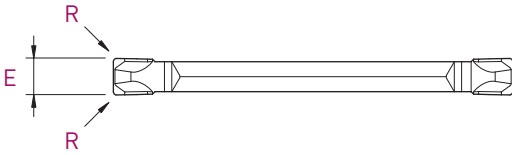
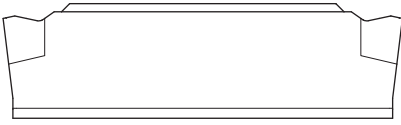

Type	E ±0.1	R	Art. N°	TiAlN	Tmax	Zmax
CUT22	2.2	0.20	CUT22-TN-002	■	■	■
CUT31	3.1	0.20	CUT31-TN-002	■	■	■

Plaquettes de fonçage, tournage et tronçonnage
 WSP zum einstecken, drehen und abstechen
 Solid carbide inserts for grooving, turning and cut off

GN Series

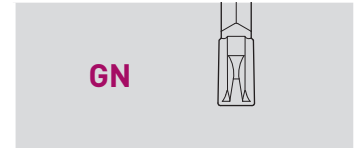
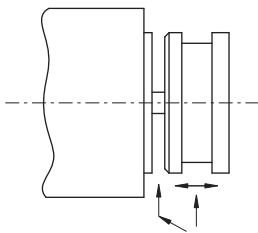
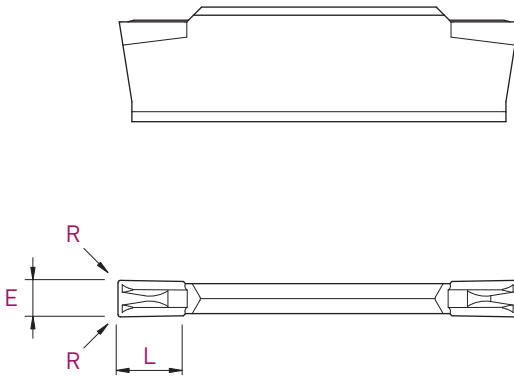

Type	E ±0.1	L	R	Art. N°	TiAlN	Tmax	AS
CUT22	2.2	3.5	0.15	CUT22-GN-002	■	■	■
CUT31	3.1	5.0	0.15	CUT31-GN-002	■	■	■

Conseils d'utilisation pour plaquettes type GN
 Anwendungsempfehlungen für GN-Wendeleplatten
 Application recommendations for GN inserts

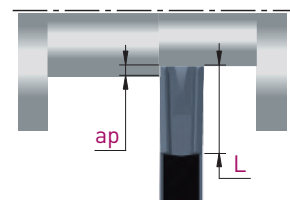
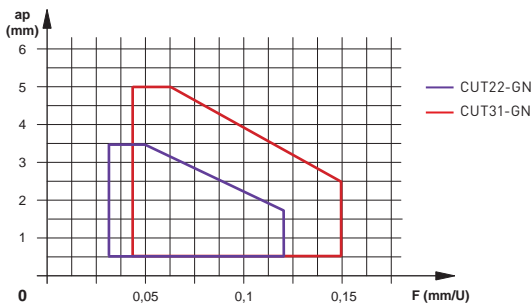

$a_p \text{ max} = T$ dans matière à bonne usinabilité
 $a_p \text{ max} = T$ in Werkstoffe mit gute Zerspanbarkeit
 $a_p \text{ max} = T$ in material with good machinability