

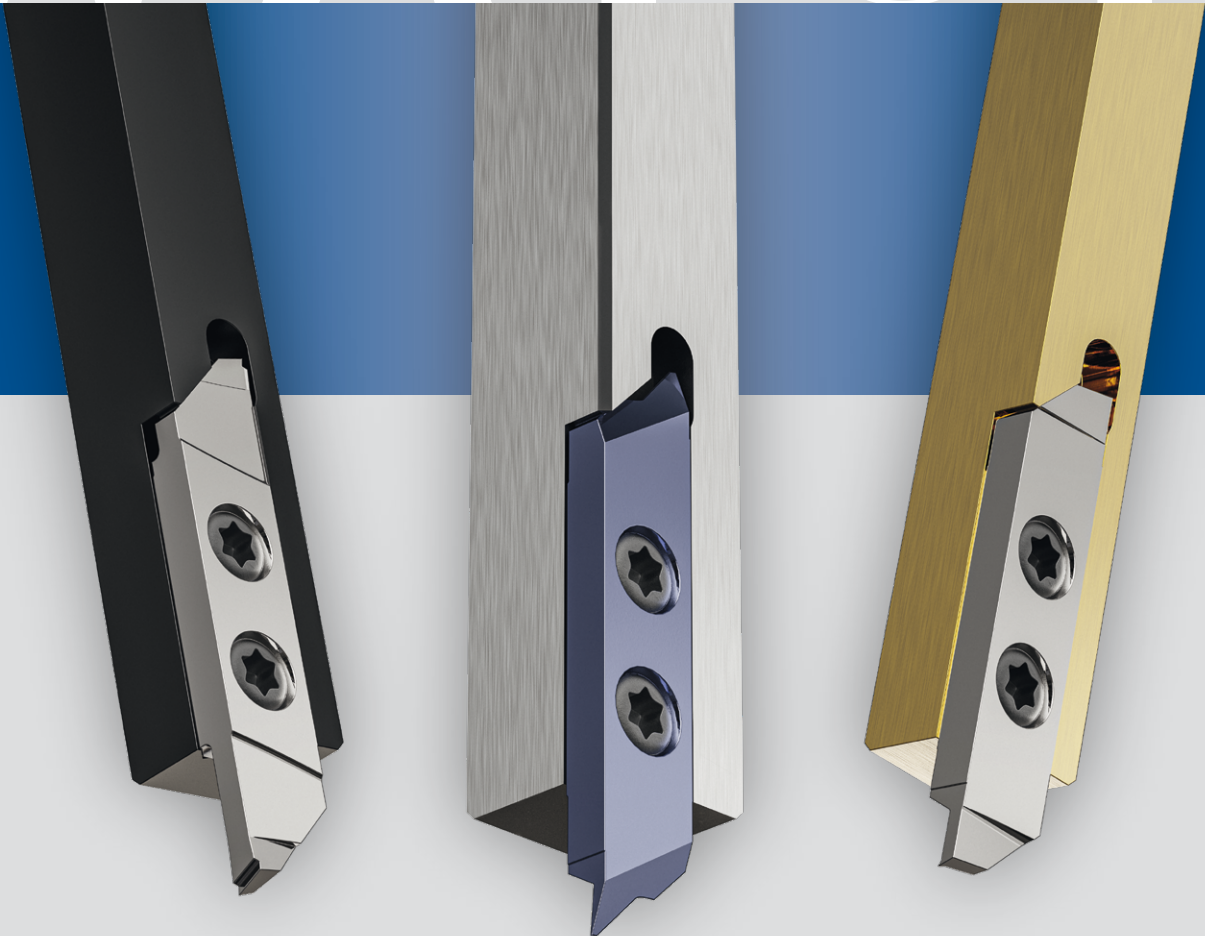

APPLITEC
SWISS TOOLING









WATCH

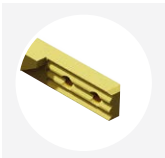

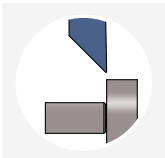
TOP-WATCH

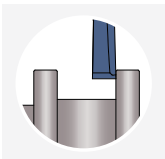
INFO > 2

Nuances micro-grain à dureté élevée
 Verschleissfeste Feinkornsorten
 Wear resistant micro-grain grades > 4

	pour machines à cames für kurvengesteuerte Maschinen for cam driven machines		pour machines CNC für CNC-Maschinen for CNC driven machines		
	L		L	R	
	710 710SF 710-NOVIBRA	> 8	730 730-NOVIBRA	740 740SF 740-NOVIBRA	> 18
	711SF	> 11		741SF	> 22
	712SF	> 13		742SF	> 26
	713SF	> 15		743SF	> 30
				744SF	> 35
			736SF	746SF	> 36
				748SF	> 38
				749SF	> 39

	pour machines à cames für kurvengesteuerte Maschinen for cam driven machines		pour machines CNC für CNC-Maschinen for CNC driven machines	
	L		L	R
	711-ESF	> 17	731-ESF	741-ESF > 40

Coupe à droite déportée / Versetztes Rechtsschneiden / Right cut off line

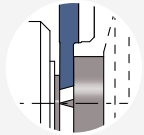
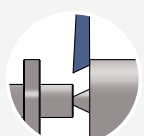
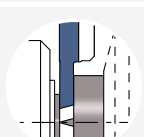
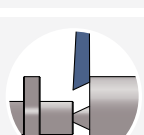
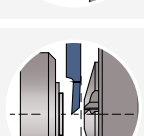
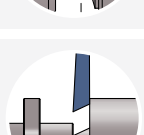
	730RC	> 41
	731RSF	> 42
	750RC	> 44
	751RDSF	> 45
	770-SN-SF	> 46
	771RVSF	> 48
Halter für SwissNano Porte-outils pour SwissNano - MODU-Line Holder for SwissNano	ML12	> 48

TOP-WATCH

Codification des plaquettes TOP-Watch série 700

WSP-Bezeichnungssystem für TOP-Watch 700 Serie

Inserts designation key for TOP-Watch 700 series

7 **4** **4** **SF** **-** **X412** **-** **0.8** **-** **HTAXF**

Super finish

Dimension
Abmessung
Dimension

Nuance
Sorte
Grade

Géométrie de coupe / Brise-copeaux / Particularités
Schneidgeometrie / Spanbrecher / Sondereigenschaften
Cutting geometry / Chip breaker / Special features

Géométrie d'usinage
Bearbeitungsgeometrie
Machining geometry

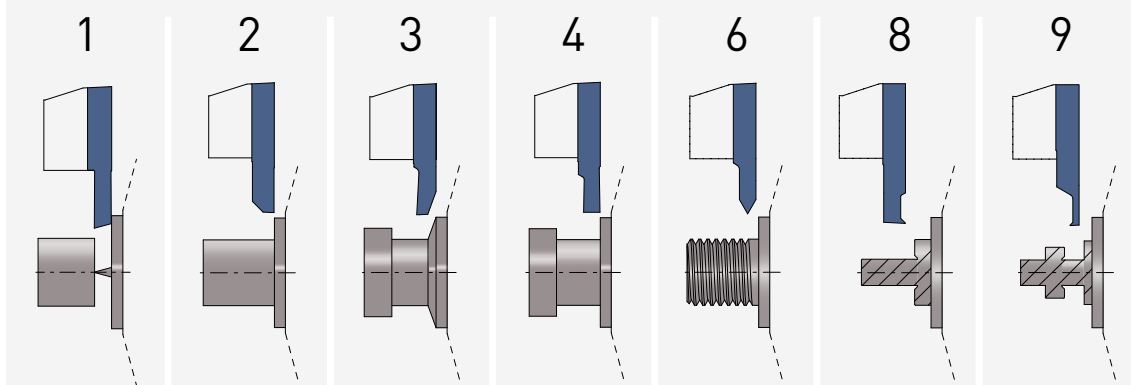

Gamme de produit
Produktserie
Product series

définit la compatibilité des plaquettes avec le porte-outil
bestimmt die WSP und Halter Kompatibilität
shows the inserts and holder compatibility

L = 1, 3, 5, 7 (chiffre impair / ungerade Zahl / uneven number)

R = 4 (chiffre pair / gerade Zahl / even number)

L
710

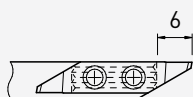

pour machines à cames
für kurvengesteuerte Maschinen
for cam driven machines

L R
730 740

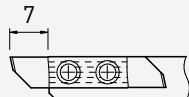

main series
small type

L
750

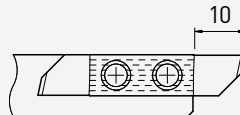

main series
large type

L
770

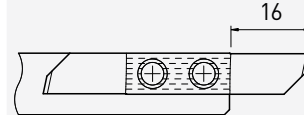

tronçonnage uniquement
nur für abstechen
only for parting off

Applitec série 700
Applitec 700 Serie
Applitec 700 series

Système de serrage à denture décalée avec 2 vis de fixation
Spannsystem mit 2 Schrauben und verschobener Verzahnung
Shifted teeth clamping system with 2 screws

L'outil de référence pour le décolletage

Hochwertiges Wendplattensystem für Langdrehautomaten

Top class turning tool for automatic lathes

700 Series

100% rigid!

Système de serrage Applitec à denture décalée
 Applitec-Spannsystem mit verschobener Verzahnung
 Applitec clamping system with shifted teeth

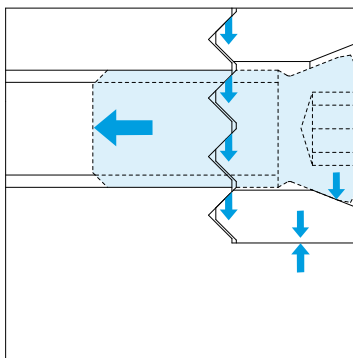
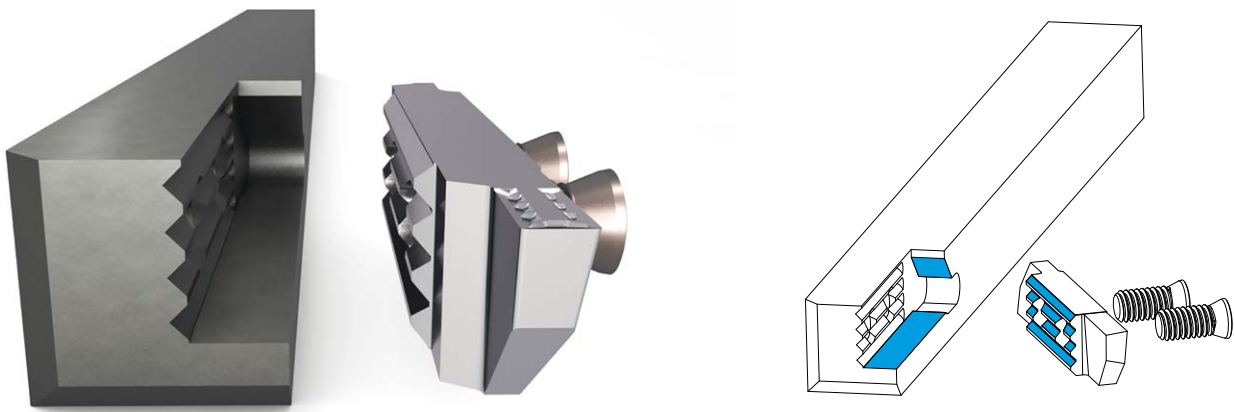

Serrage standard (A)
Standard Spannsystem (A)
Standard clamping system (A)

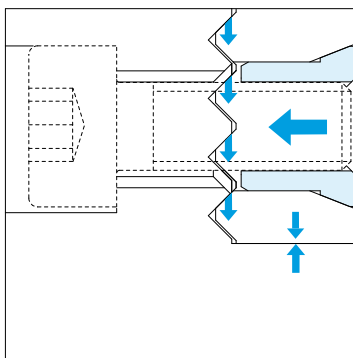
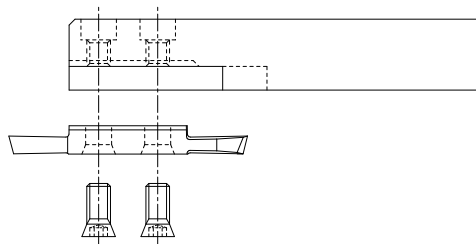

Serrage type B*
Spannsystem Typ B*
Clamping system type B*

ajouter -B après le numéro d'article
 -B nach der Artikelreferenz hinzufügen
 add -B after the article number

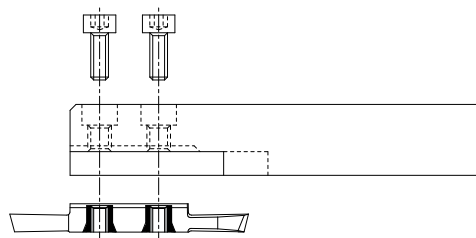

Changement de la plaquette possible dans la machine, sans démontage du porte-outil
 WSP-Austauschmöglichkeit in der Maschine ohne Halterausbau
 The insert can be changed in the machine without removing the tool holder

* = sur demande / auf Anfrage / on request

Nuances micro-grain à dureté élevée

Verschleissfeste Feinkornsorten

Wear resistant micro-grain grades

N (μ K20)

non revêtu
unbeschichtet
uncoated

- nuance micro-grain tenace, résistante aux conditions défavorables, recommandée pour des opérations de coupe dans des matières ne nécessitant aucun revêtement
- zähe Feinkornsorte, in ungünstige Bearbeitungskonditionen widerstandsfähig, für Schnittbearbeitung empfohlen, die keine Beschichtung erfordern
- tough micro-grain grade, suitable for unfavorable machining conditions, suitable for cutting in material that do not necessitate any tool coating

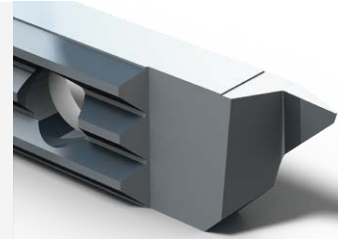

TAF

μ K20 + revêtement PVD
 μ K20 + PVD Beschichtung
 μ K20 + PVD coating

- nuance tenace résistante aux conditions défavorables, recommandée pour des opérations de coupes dans les aciers et aciers inoxydables.
- zähe widerstandsfähige Sorte in ungünstigen Bearbeitungskonditionen, für Schnittbearbeitung in Stahl und rostfreiem Stahl empfohlen
- tough grade, resistant to unfavorable machining conditions, suitable for cutting of steel and stainless steel



HN (μ K10)

non revêtu
unbeschichtet
uncoated

- nuance micro-grain, bonne résistance à l'usure, recommandée pour des opérations d'ébauche et de finition pour des matières ou usinages ne nécessitant aucun revêtement
- verschleissfeste Feinkornsorte, für Schruppen und Schlichtbearbeitung empfohlen oder für Werkstoffe oder Bearbeitungen, die keine Beschichtung erfordern
- wear resistant micro-grain carbide, recommended for roughing and finishing and for materials or operations that do not necessitate any tool coating

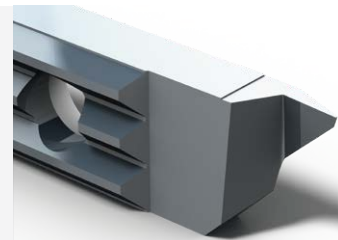

HTC

μ K10 + revêtement PVD
 μ K10 + PVD Beschichtung
 μ K10 + PVD coating

- nuance résistante à l'usure, faible coefficient de frottement, recommandée pour des opérations d'ébauche et de finition
- verschleissfeste Sorte, geringer Reibwert, für Schruppen und Schlichtbearbeitung empfohlen
- wear resistant grade, low friction ratio, recommended for roughing and finishing

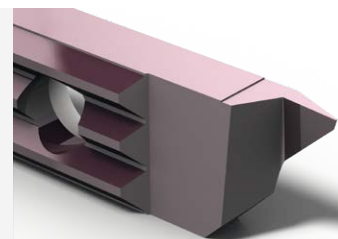

conseillée pour l'usinage de la matière 20AP
für Bearbeitung von 20AP geeignet
suitable for machining of 20AP material

HTC-RE

μ K10 + revêtement PVD
 μ K10 + PVD Beschichtung
 μ K10 + PVD coating

- nuance identique à HTC avec dépouilles rectifiées après revêtement pour des opérations de finition
- gleiche Sorte wie HTC nach der Beschichtung geschliffener Freiwinkel, für Schlichtbearbeitung empfohlen
- same grade as HTC, after coating grounded clearance, recommended for finishing

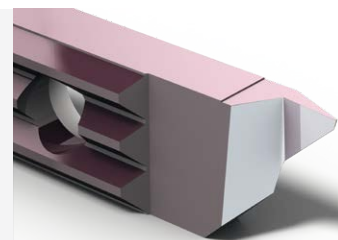

conseillée pour l'usinage de la matière 20AP
für Bearbeitung von 20AP geeignet
suitable for machining of 20AP material

Nuances micro-grain à dureté élevée

Verschleissfeste Feinkornsorten

Wear resistant micro-grain grades

HTAF

μK10 + revêtement PVD
μK10 + PVD Beschichtung
μK10 + PVD coating

- nuance résistante à l'usure, recommandée pour des opérations d'ébauche et de finition
- verschleissfeste Sorte, für Schruppen und Schlichtbearbeitung empfohlen
- wear resistant grade, recommended for roughing and finishing



*conseillée pour l'usinage des matières Finemac et inox 4c27a
für Bearbeitung von Finemac und 4c27a-Rostfreier Stahl geeignet
suitable for machining of Finemac and 4c27a stainless steel*

HTAF-RE

μK10 + revêtement PVD
μK10 + PVD Beschichtung
μK10 + PVD coating

- nuance identique à HTAF avec dépouilles rectifiées après revêtement pour des opérations de finition
- gleiche Sorte wie HTAF nach der Beschichtung geschliffener Freiwinkel, für Schlichtbearbeitung empfohlen
- same grade as HTAF, after coating grounded clearance, recommended for finishing



*recommandée pour les matières Finemac et inox 4c27a
für Bearbeitung von Finemac und 4c27a-Rostfreier Stahl geeignet
suitable for machining of Finemac and 4c27a stainless steel*

HTAXF

μK10 + revêtement PVD
μK10 + PVD Beschichtung
μK10 + PVD coating

- nuance complémentaire, résistante à l'usure et à la température pour l'usinage ébauche et finition des matières inox 304, 316L, 317L, 904, Phynox Aciers alliés contenant: Chrome Nickel, Vanadium, molybdène...
- komplementäre Sorte, verschleissfest und temperaturbeständig. Für Schruppen und Schlichtbearbeitung von Materialien Inox 304, 316L, 317L, 904, Phynox Legierter Stahl enthaltend Chrom-Nickel, Vanadium, Molybdän...
- complementary grade, wear and temperature resistant for roughing and finishing of following materials: Inox 304, 316L, 317L, 904, Phynox Alloy steel containing Chrome-nickel, Vanadium, Molybdenum...

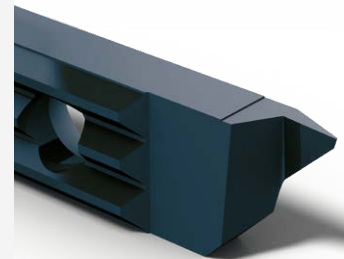

HTAXF-RE

μK10 + revêtement PVD
μK10 + PVD Beschichtung
μK10 + PVD coating

- nuance identique à HTAXF avec dépouilles rectifiées après revêtement pour des opérations de finition
- gleiche Sorte wie HTAXF nach der Beschichtung geschliffener Freiwinkel, für Schlichtbearbeitung empfohlen
- same grade as HTAXF, after coating grounded clearance, recommended for finishing

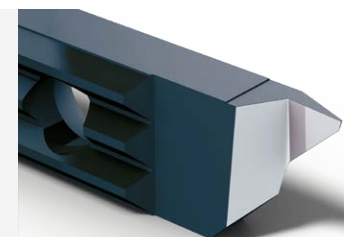

Nuances micro-grain à dureté élevée

Verschleissfeste Feinkornsorten

Wear resistant micro-grain grades

HCR-TF

μK10 + revêtement PVD
μK10 + PVD Beschichtung
μK10 + PVD coating

- nuance spécifique aux matériaux non ferreux tels que cuivre, laiton, laiton sans plomb, bronze, maillechort. Réduit le collage. Alternative aux revêtements DLC pour certains domaines d'applications
- spezifische Sorte für Nichteisenmetalle wie Kupfer, Messing, bleifreies Messing, Bronze, Neusilber. Verringerung des Klebens. Alternative zu DLC-Beschichtungen in gewissen Einsatzbereichen
- specific grade for non-ferrous materials such as copper, brass, lead-free brass, bronze and nickel silver. Reduces sticking. Alternative to DLC coatings for certain applications

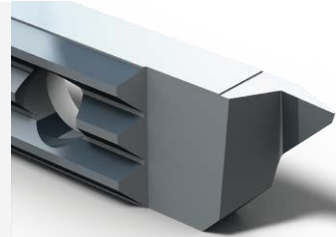

HTiN

μK10 + revêtement PVD
μK10 + PVD Beschichtung
μK10 + PVD coating

- nuance résistante à l'usure, faible coefficient de frottement, recommandée pour des opérations d'ébauche et de finition
- verschleissfeste Sorte, geringer Reibwert, für Schruppen und Schlichtbearbeitung empfohlen
- wear resistant grade, low friction ratio, recommended for roughing and finishing



XN (μK01)

non revêtu
unbeschichtet
uncoated

- nuance micro-grain très résistante à l'usure, recommandée pour des opérations d'ébauche et de finition pour des matières ou usinages nécessitant aucun revêtement
- sehr verschleissfeste Sorte, für Schruppen und Schlichtbearbeitung empfohlen oder für Werkstoffe oder Bearbeitungen, die keine Beschichtung erfordern
- wear resistant micro-grain carbide, recommended for roughing and finishing and for materials or operations that do not necessitate any tool coating

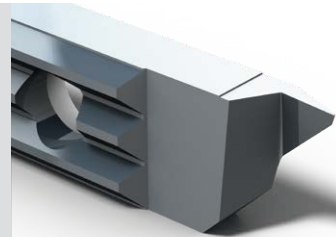

XTC

μK01 + revêtement PVD
μK01 + PVD Beschichtung
μK01 + PVD coating

- nuance très résistante à l'usure, faible coefficient de frottement, recommandée pour des opérations de finition
- sehr verschleissfeste Sorte, geringer Reibwert, für Schlichtbearbeitung empfohlen
- very wear resistant grade, low friction ratio, recommended for finishing



XTAF

μK01 + revêtement PVD
μK01 + PVD Beschichtung
μK01 + PVD coating

- nuance très résistante à l'usure, recommandée pour des opérations de finition, conseillée pour l'usinage des matières très abrasives
- sehr verschleissfeste Sorte, für Schlichtbearbeitung empfohlen, für die Bearbeitung von sehr abrasive Rohstoffe geeignet
- very wear resistant grade, recommended for finishing, suitable for machining of very abrasive materials



Nuances micro-grain à dureté élevée

Verschleissfeste Feinkornsorten

Wear resistant micro-grain grades

XTAF-RE

μK01 + revêtement PVD
μK01 + PVD Beschichtung
μK01 + PVD coating

- nuance identique à XTAF avec dépouilles rectifiées après revêtement pour des opérations de finition
- gleiche Sorte wie XTAF nach der Beschichtung geschliffener Freiwinkel, für Schlichtbearbeitung empfohlen
- same grade as XTAF, after coating grounded clearance, recommended for finishing



XTAXF

μK01 + revêtement PVD
μK01 + PVD Beschichtung
μK01 + PVD coating

- nuance complémentaire très résistante à l'usure et à la température pour la finition des matières inox 304, 316L, 317L, 904, Phynox
Aciers alliés contenant: Chrome Nickel, Vanadium, molybdène...
- komplémentere Sorte, sehr verschleissfest und temperaturbeständig. Für Schlichtbearbeitung von Materialien Inox 304, 316L, 317L, 904, Phynox
Legierter Stahl enthaltend Chrom-Nickel, Vanadium, Molybdän...
- complementary grade, very wear and temperature resistant for finishing of following materials: Inox 304, 316L, 317L, 904, Phynox
Alloy steel containing Chrome-nickel, Vanadium, Molybdenum...

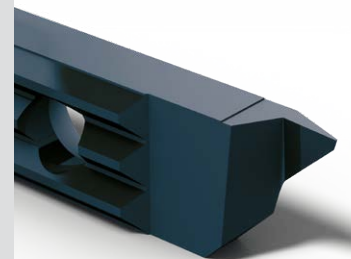

XTAXF-RE

μK01 + revêtement PVD
μK01 + PVD Beschichtung
μK01 + PVD coating

- nuance identique à XTAXF avec dépouilles rectifiées après revêtement pour des opérations de finition
- gleiche Sorte wie XTAXF nach der Beschichtung geschliffener Freiwinkel, für Schlichtbearbeitung empfohlen
- same grade as XTAXF, after coating grounded clearance, recommended for finishing

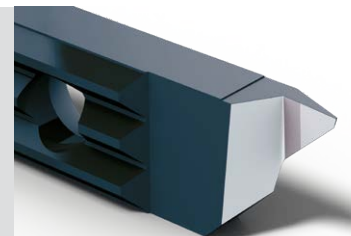

Porte-outils

Halter

Holder

L

710

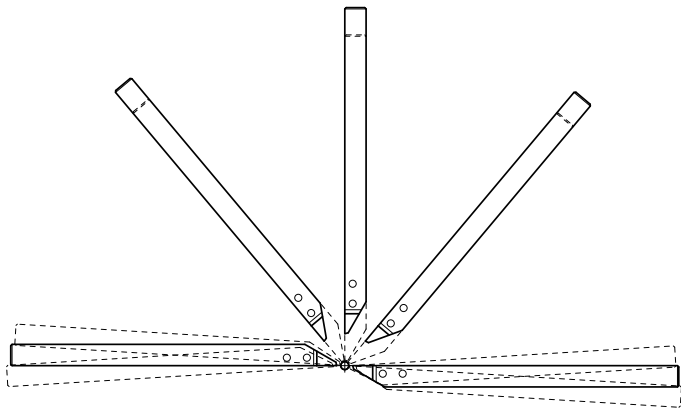

Porte-outils pour machines à cames à gauche
 Halter für linksdrehende kurvengesteuerte Maschinen
 Tool holders for left hand turning cam driven machines

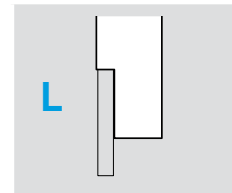
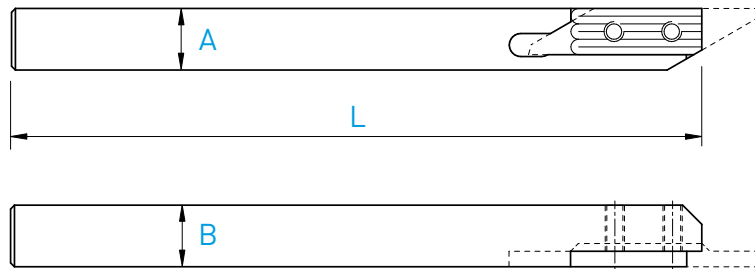

A x B	L	Serrage Spannsystem Clamping	Art. N°
6 x 6	115	A	710-6
7 x 7	115	A	710-7
8 x 8	115	A	710-8
8 x 8	140	A	710-8-140
10 x 10	115	A	710-10
12 x 12	130	A	710-12



Porte-outils Halter Holder	Serrage standard (A) Standard Spannsystem (A) Standard clamping system (A)	
710-6	V-M2.5X5.8-T8	C-T8
710-7	V-M2.5X6.5-T8	
710-8		
710-10	V-M2.5X7.8-T8	
710-12		

Chaque support est livré avec vis et clé.
 Jeder Halter wird mit Spannschraube(n) und Schlüssel geliefert.
 Screw(s) and key are included with each tool holder.

Porte-outils
 Halter
 Holders

L

710-SF

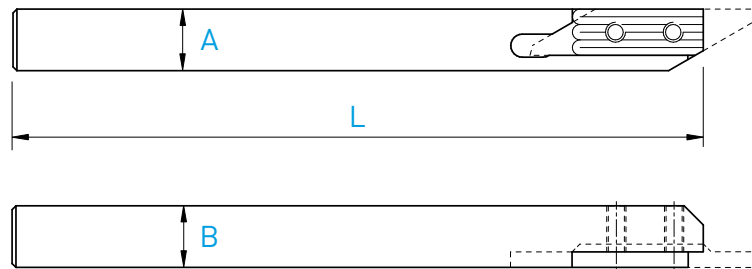

Super finition des 4 faces
 4 seitig feinstgeschliffen
 4 sides superfinish

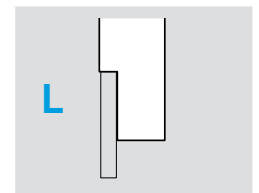

A x B	L	Serrage Spannsystem Clamping	Art. N°
7 x 7	140	A	710-7-140-SF
8 x 8	140	A	710-8-140-SF

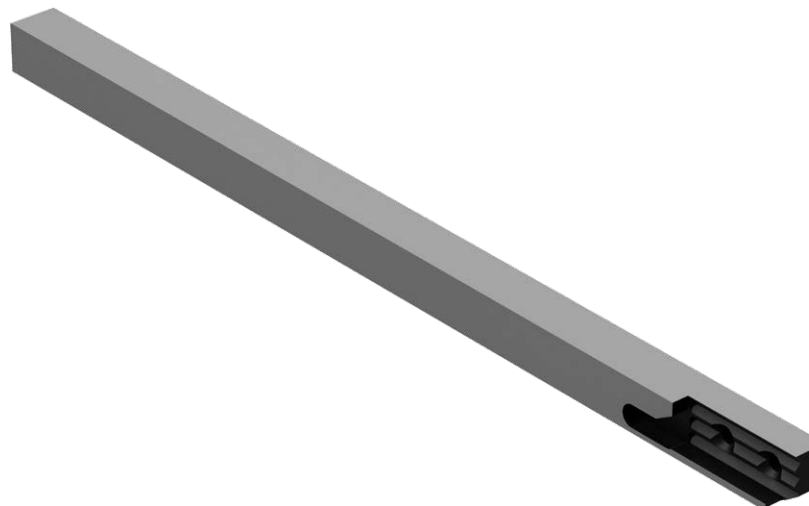

Porte-outils Halter Holders	Serrage standard (A) Standard Spannsystem (A) Standard clamping system (A)	
710-7-SF	V-M2.5X6.5-T8	C-T8
710-8-SF	V-M2.5X7.8-T8	

Chaque support est livré avec vis et clé.
 Jeder Halter wird mit Spannschraube(n) und Schlüssel geliefert.
 Screw(s) and key are included with each tool holder.

Porte-outils en métal lourd anti-vibratoire
 Schwingungdämpfender Schwermetallhalter
 Low vibration heavy metal holders

L

710-NOVIBRA

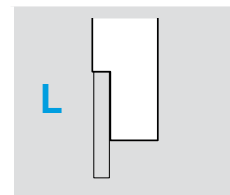
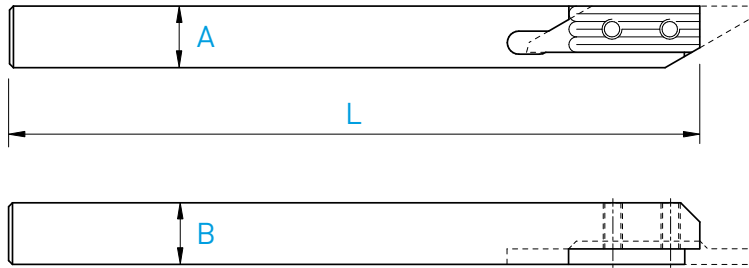

A x B	L	Serrage Spannsystem Clamping	Art. N°
6 x 6	115	A	710-6-NOVIBRA
7 x 7	115	A	710-7-NOVIBRA
8 x 8	115	A	710-8-NOVIBRA

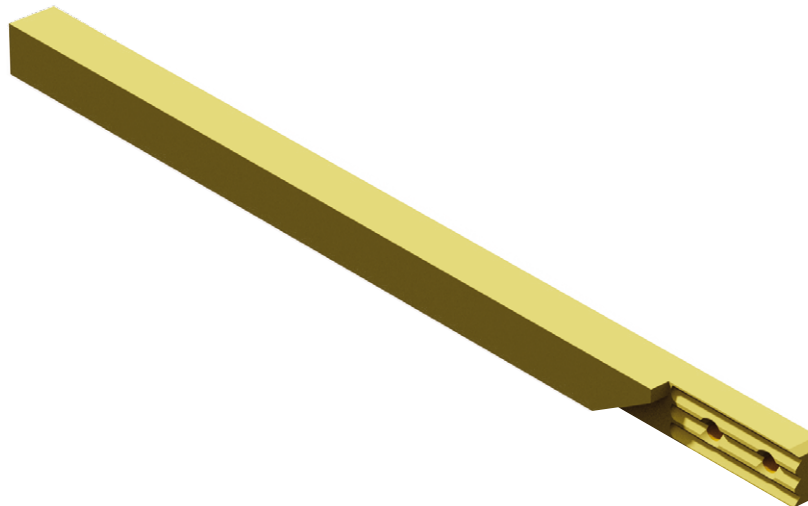

Porte-outils Halter Holders	Serrage standard (A) Standard Spannsystem (A) Standard clamping system (A)	
710-6-NOVIBRA	V-M2.5X5.8-T8	C-T8
710-7-NOVIBRA	V-M2.5X6.5-T8	
710-8-NOVIBRA	V-M2.5X7.8-T8	

Chaque support est livré avec vis et clé.
 Jeder Halter wird mit Spannschraube(n) und Schlüssel geliefert.
 Screw(s) and key are included with each tool holder.

- Tronçonnage
- Abstechen
- Parting off

L

711SF

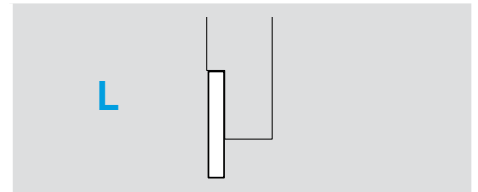
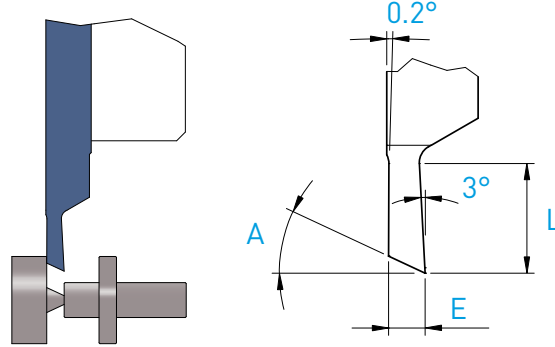

E	L	A	Art. N°	HTC	HTC-RE	HTAF	HTiN	HN (μK10)
0.8	3.0	25°	711SF-0.8-25°	■	■	■	■	■
1.0	3.0	25°	711SF-1.0-25°	■	□	■	□	■

■ = disponible / verfügbar / available
 □ = selon disponibilité du stock / jenach Lagerverfügbarkeit / depending on stock availability

Coupe rentrant

Abstechen Zenturfrei

Pip-free back parting off

L

711SF-A

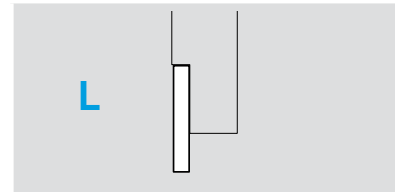
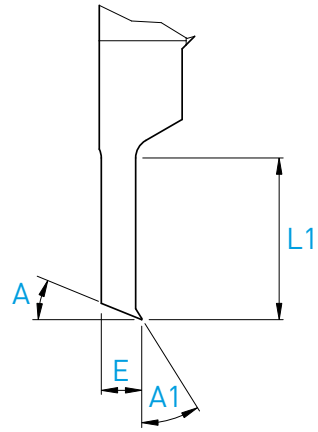
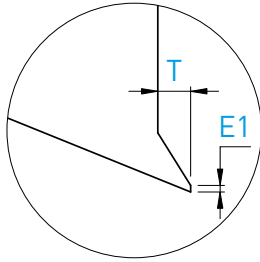
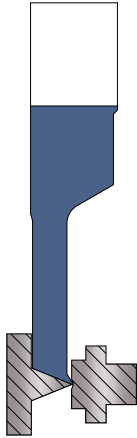

E1	E	A	A1	T	L1	Art. N°	TAF-RE	Z
0.03	0.8	22°	32°	0.15	4	711SF-0.8-22°-A3215	■	■
0.03	1.0	22°	32°	0.15	4	711SF-1.0-22°-A3215	■	■

Tournage avant ébauche / finition
 Vorwärts drehen schruppen / schlichten
 Front turning for roughing / finishing

L

712SF

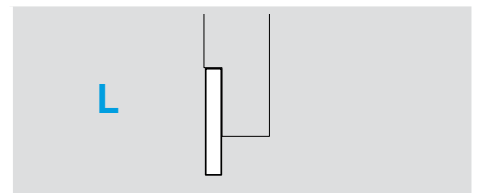
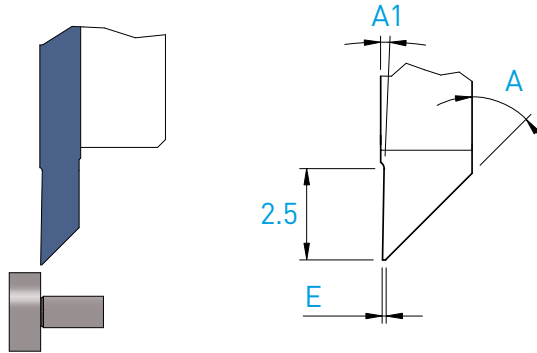

E	A	A1	Art. N°	HTC	HTC-RE	HTAF	HTiN	HN (µK10)
0.03	45°	3°	712SF-3/3-45°	■	□	■	□	■
0.08	45°	1°	712SF-8/8-45°	■	■	■	□	■

■ = disponible / verfügbar / available
 □ = selon disponibilité du stock / jenach Lagerverfügbarkeit / depending on stock availability

TOP-WATCH

Tournage avant finition (pivotage)

Vorwärts drehen schlichten

Front turning for finishing

L

712SF-10/3

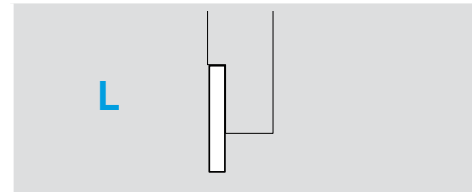
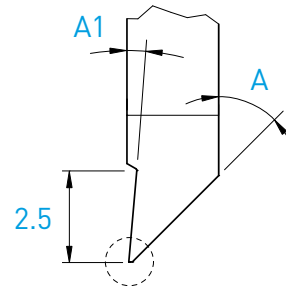
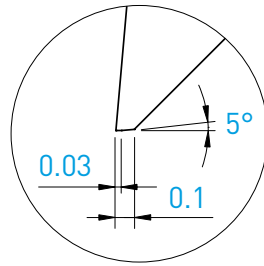
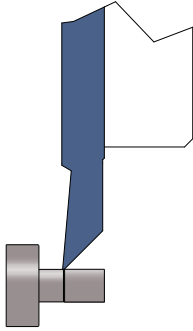

A	A1	Art. N°	HTC	HTC-RE	HTAF	HTiN	HN (μK10)
45°	3°	712SF-10/3	■	□	■	■	■

- Tournage arrière ébauche / finition
- Rückwärts drehen schrappen / schlichten
- Back turning for roughing / finishing

L

713SF

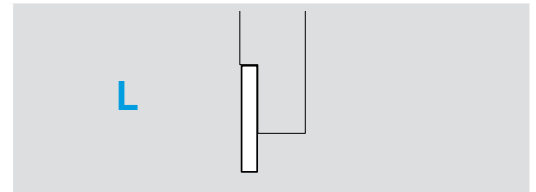
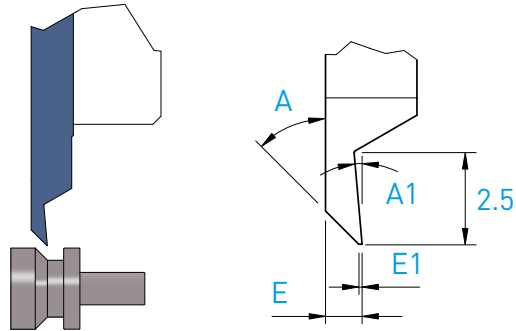

E1	E	A	A1	Art. N°	HTC	HTC-RE	HTAF	HTiN	HN (µK10)
0.03	1.0	45°	5°	713SF-3/3-45°-1.0	■	□	■	□	■
0.10	1.0	45°	5°	713SF-10/10-45°-1.0	■	□	■	□	■

■ = disponible / verfügbar / available
 □ = selon disponibilité du stock / jenach Lagerverfügbarkeit / depending on stock availability

TOP-WATCH

- Tournage arrière finition
- Rückwärts drehen schlichten
- Back turning for finishing

L

713SF-10/3

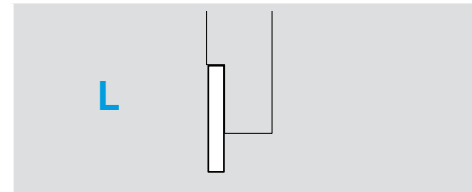
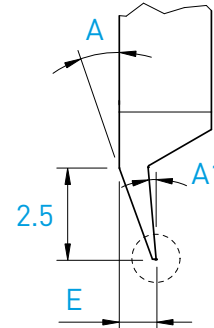
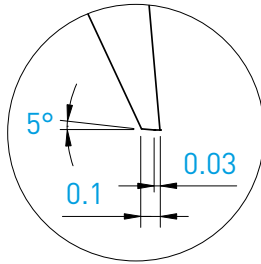
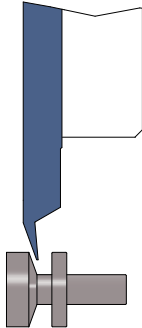

E	A	A1	Art. N°	HTC	HTC-RE	HTAF	HTiN	HN (μK10)
1.0	20°	5°	713SF-10/3	■	□	■	■	■

- Plaquettes ébauches
- WSP-Rohlinge
- Blank inserts

L

711-ESF

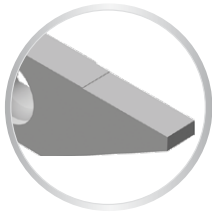
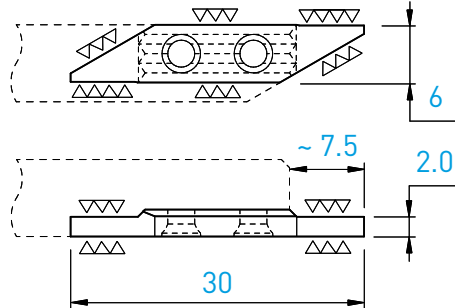

L							
Art. N°	HTC	HTAF	HTiN	HN (μK10)	XN (μK01)	XTC	XTAF
711-ESF	■	■	□	■	■	■	■

■ = disponible / verfügbar / available
 □ = selon disponibilité du stock / jenach Lagerverfügbarkeit / depending on stock availability

Porte-outils

Halter

Holder

L/R

730 / 740

L

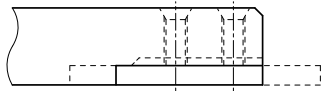
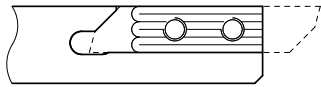

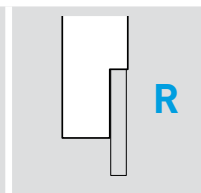
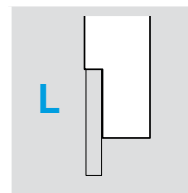
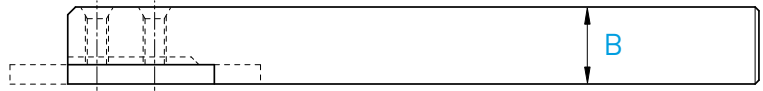
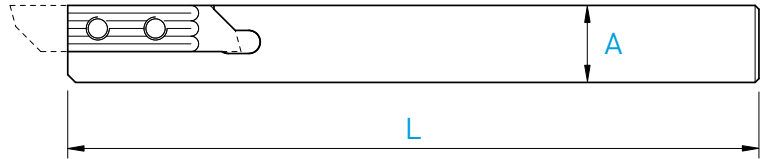

R



A x B	L	Serrage Spannsystem Clamping	Art. N°	Art. N°
7 x 7	115	A	730-7	740-7
8 x 8	115	A + B	730-8	740-8
8 x 8	140	A + B	730-8-140	-
10 x 10	115	A + B	730-10	740-10
12 x 12	130	A + B	730-12	740-12
12 x 12	90	A + B	730-12-90	740-12-90

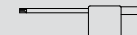

Porte-outils Halter Holder	Serrage standard (A) Standard Spannsystem (A) Standard clamping system (A)		Serrage standard (B) Standard Spannsystem (B) Standard clamping system (B)	
				
730/740-7			-	-
730/740-8	V-M3X7-T8	C-T8		
730/740-10			V-M2.5X7.8-T8	C-T8
730/740-12				

Chaque support est livré avec vis et clé.
Jeder Halter wird mit Spannschraube(n) und Schlüssel geliefert.
Screw(s) and key are included with each tool holder.

Porte-outils
 Halter
 Holders

R

740-SF

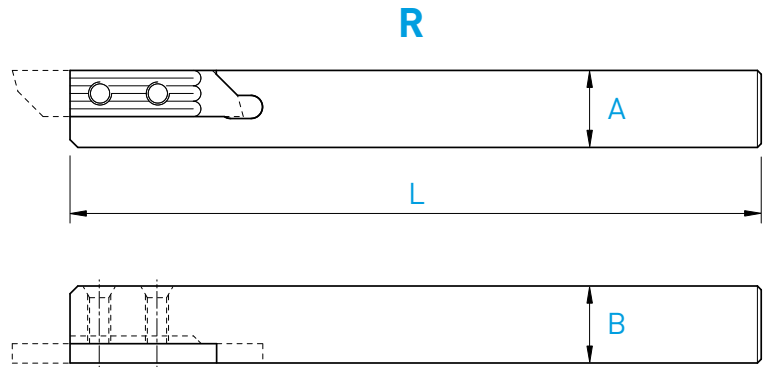

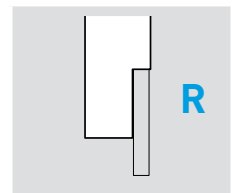

Super finition des 4 faces
 4 seitig feinstgeschliffen
 4 sides superfinish



A x B	L	Serrage Spannsystem Clamping	Art. N°
7 x 7	90	A	740-7-90-SF
8 x 8	115	A + B	740-8-SF
8 x 8	90	A + B	740-8-90-SF
10 x 10	115	A + B	740-10-SF
10 x 10	90	A + B	740-10-90-SF
12 x 12	130	A + B	740-12-SF
12 x 12	90	A + B	740-12-90-SF

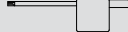

Porte-outils Halter Holders	Serrage standard (A) Standard Spannsystem (A) Standard clamping system (A)		Serrage standard (B) Standard Spannsystem (B) Standard clamping system (B)	
				
740-SF-7			-	-
740-SF-8	V-M3X7-T8	C-T8		
740-SF-10				
740-SF-12			V-M2.5X7.8-T8	C-T8

Chaque support est livré avec vis et clé.
 Jeder Halter wird mit Spannschraub(e)n und Schlüssel geliefert.
 Screw(s) and key are included with each tool holder.

Porte-outils en métal lourd anti-vibratoire
 Schwingungdämpfender Schwermetallhalter
 Low vibration heavy metal holders

L/R

730 / 740-NOVIBRA

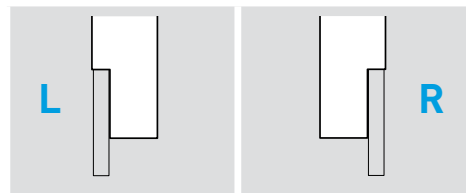
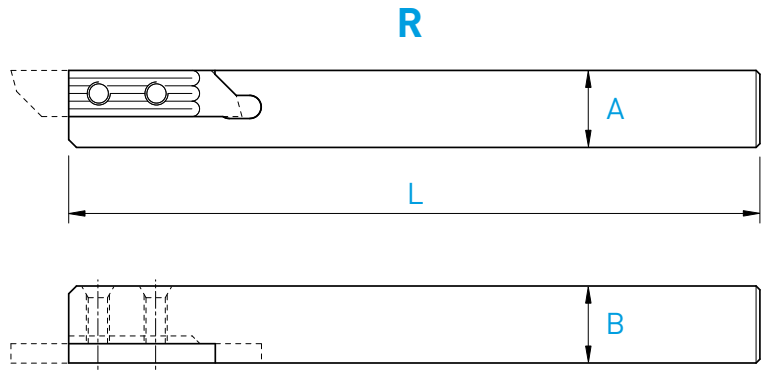
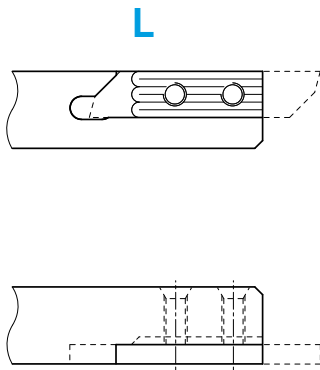

A x B	L	Serrage Spannsystem Clamping	Art. N°	Art. N°
7 x 7	115	A	730-7-NOVIBRA	740-7-NOVIBRA
8 x 8	115	A + B	730-8-NOVIBRA	740-8-NOVIBRA
8 x 8	80	A + B	-	740-8-80-NOVIBRA
10 x 10	115	A + B	-	740-10-NOVIBRA
12 x 12	130	A + B	-	740-12-NOVIBRA



Porte-outils Halter Holders	Serrage standard (A) Standard Spannsystem (A) Standard clamping system (A)	Serrage standard (B) Standard Spannsystem (B) Standard clamping system (B)
730/740-NOVIBRA-7		
730/740-NOVIBRA-8	V-M3X7-T8	C-T8
740-NOVIBRA-10		V-M2.5X7.8-T8
740-NOVIBRA-12		C-T8

Chaque support est livré avec vis et clé.
 Jeder Halter wird mit Spannschraube(n) und Schlüssel geliefert.
 Screw(s) and key are included with each tool holder.

- Porte-outils
- Halter
- Holder

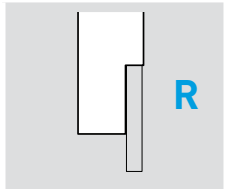
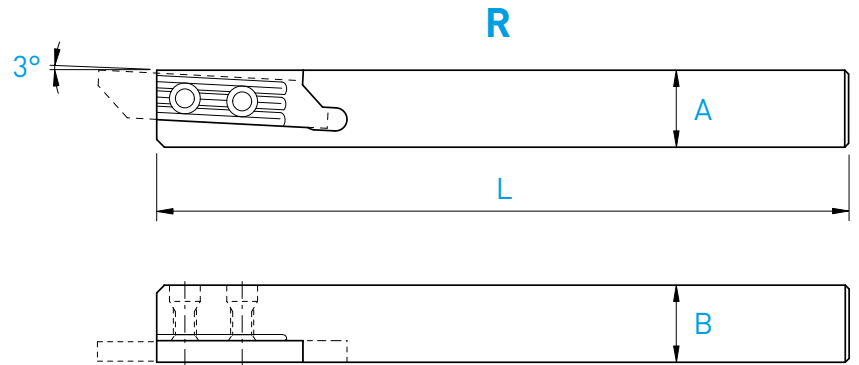

R

740X3-SF

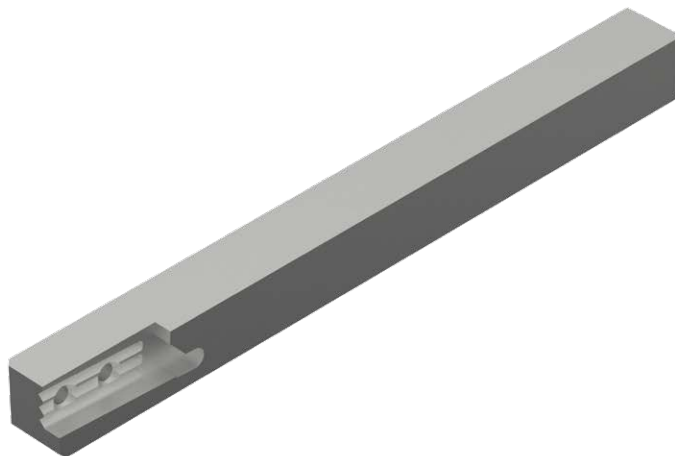

A x B	L	Serrage Spannsystem Clamping	Art. N°
8 x 8	115	A + B	740X3-8-SF
10 x 10	115	A + B	740X3-10-SF
12 x 12	130	A + B	740X3-12-SF

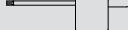

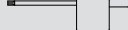
Porte-outils Halter Holder	Serrage standard (A) Standard Spannsystem (A) Standard clamping system (A)		Serrage standard (B) Standard Spannsystem (B) Standard clamping system (B)	
				
740X-SF-8				
740X-SF-10	V-M3X7-T8	C-T8	V-M2.5X7.8-T8	C-T8
740X-SF-12				

Chaque support est livré avec vis et clé.
 Jeder Halter wird mit Spannschraub(e)n und Schlüssel geliefert.
 Screw(s) and key are included with each tool holder.

Tronçonnage

Abstechen

Parting off

R

741SF

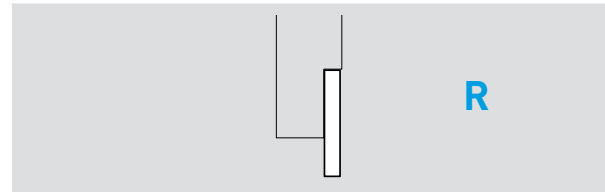
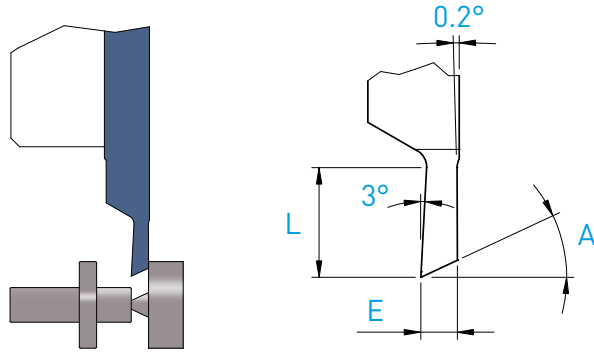

E	L	A	Art. N°	HTC	HTC-RE	HTAF	HTAF-RE	HTAXF	HTAXF-RE	HTiN	HN (μK10)	XTAF	XTAXF	XTAXF-RE	XN (μK01)
0.5	2.0	25°	741SF-0.5-25°	■	□	■	□	■	□	■	■	■	■	□	□
0.8	3.0	25°	741SF-0.8-25°	■	□	■	□	■	□	■	■	■	■	□	□
1.0	3.0	25°	741SF-1.0-25°	■	□	■	■	■	■	□	■	■	■	□	■
1.2	6.0	22°	741SF-1.2-22°	■	□	■	■	■	■	□	■	■	■	□	□

7XX-XX-B



Sur demande pour serrage type B, voir page 3
Wahlweise für B-Spannsystem, siehe Seite 3
On request for B clamping system, see page 3

- Coupe rentrant
- Abstechen Zentrumfrei
- Pip-free back parting off

R

741SF-A

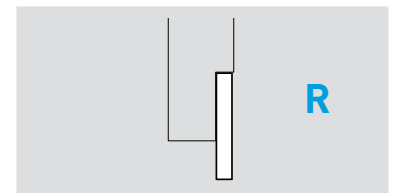
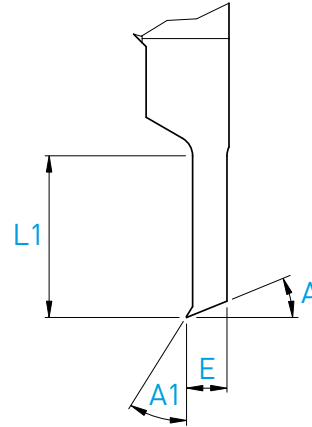
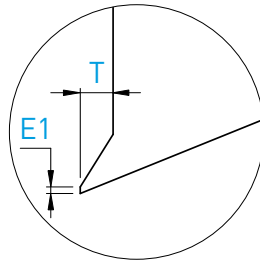
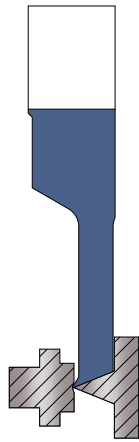

E1	E	A	A1	T	L1	Art. N°	Z	TAF-RE
0.03	0.8	22°	32°	0.15	4	741SF-0.8-22°-A3215	■	■
0.03	1.0	22°	32°	0.15	4	741SF-1.0-22°-A3215	■	■
0.03	1.2	22°	32°	0.20	6	741SF-1.2-22°-A3220	■	■



7XX-XX-B

Sur demande pour serrage type B, voir page 3
 Wahlweise für B-Spannsystem, siehe Seite 3
 On request for B clamping system, see page 3

■ = disponible / verfügbar / available
 □ = selon disponibilité du stock / je nach Lagerverfügbarkeit / depending on stock availability

- Tronçonnage
- Abstechen
- Parting off

R

741NSF-X

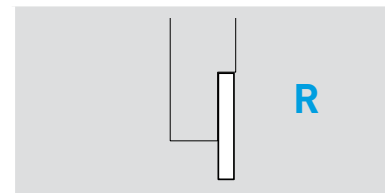
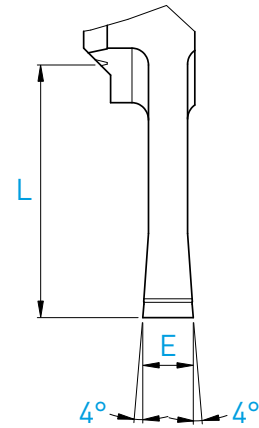
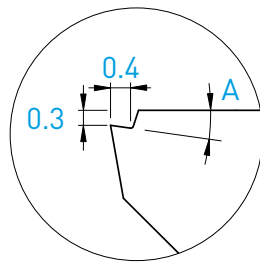
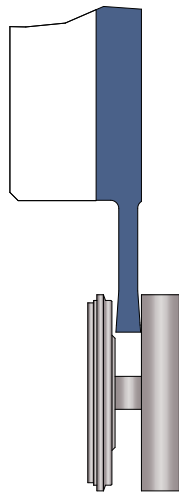

E	A	L	Art. N°	HCR-TF	HN (μK10)
1.5	8°	7.5	741NSF-X840-1.5	■	■
2.0	8°	8.0	741NSF-X840-2.0	■	■

7XX-XX-B



Sur demande pour serrage type B, voir page 3
 Wahlweise für B-Spannsystem, siehe Seite 3
 On request for B clamping system, see page 3

- Tronçonnage
- Abstechen
- Parting off

R

741SF-X

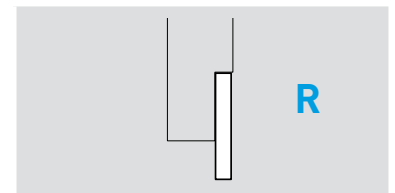
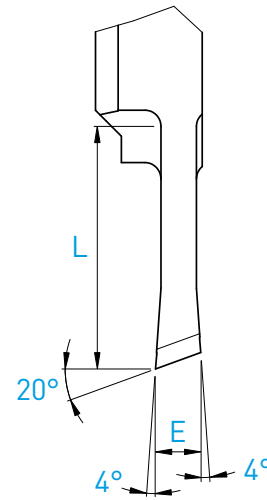
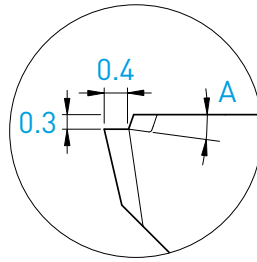
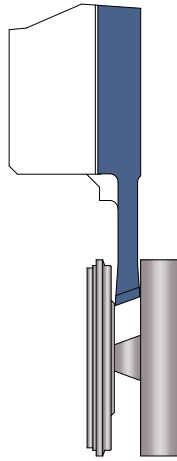

E	A	L	Art. N°	HCR-TF	HN (µK10)
1.1	8°	5.0	741SF-X840-1.1-20°	■	■
1.4	8°	7.5	741SF-X840-1.4-20°	■	■
1.5	5°	7.5	741SF-X840-1.5-5°	■	■
1.9	8°	8.0	741SF-X840-1.9-20°	■	■



7XX-XX-B

Sur demande pour serrage type B, voir page 3
 Wahlweise für B-Spannsystem, siehe Seite 3
 On request for B clamping system, see page 3

■ = disponible / verfügbar / available
 □ = selon disponibilité du stock / je nach Lagerverfügbarkeit / depending on stock availability

Tournage avant ébauche / finition
 Vorwärts drehen schruppen / schlichten
 Front turning for roughing / finishing

R

742SF

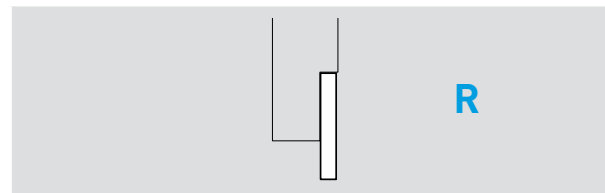
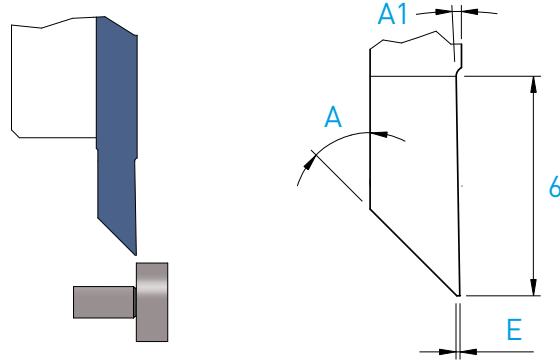

E	A	A1	Art. N°	HTC	HTC-RE	HTAF	HTAF-RE	HTAXF	HTAXF-RE	HTiN	HN (µK10)	XTAF	XTAXF	XTAF-RE	XN (µK01)
0.03	45°	3°	742SF-3/3-45°	■	■	■	■	■	■	□	■	■	■	□	■
0.08	45°	1°	742SF-8/8-45°	■	■	■	■	■	■	□	■	■	■	□	■

7XX-XX-B



Sur demande pour serrage type B, voir page 3
 Wahlweise für B-Spannsystem, siehe Seite 3
 On request for B clamping system, see page 3

Tournage avant finition
 Vorwärts drehen schlichten
 Front turning for finishing

R

742SF-10/3

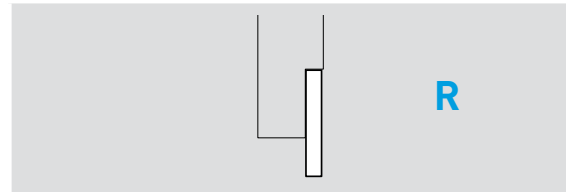
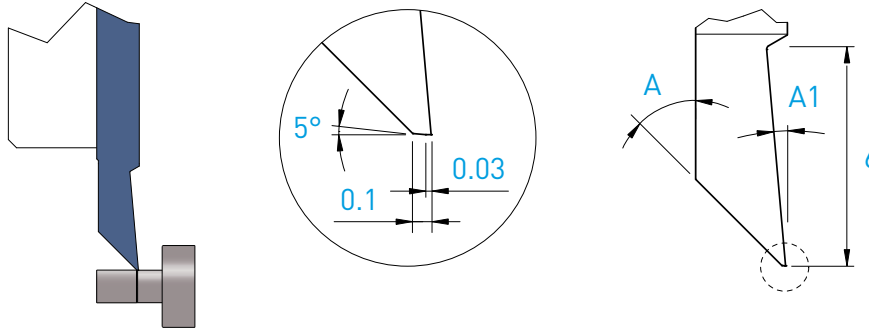

A	A1	Art. N°	HTC	HTC-RE	HTAF	HTAF-RE	HTAXF	HTAXF-RE	HTiN	HN (µK10)	XTAF	XTAXF	XTAXF-RE	XN (µK01)
45°	5°	742SF-10/3	■	■	■	□	□	■	■	■	■	■	□	□



Sur demande pour serrage type B, voir page 3
 Wahlweise für B-Spannsystem, siehe Seite 3
 On request for B clamping system, see page 3

■ = disponible / verfügbar / available
 □ = selon disponibilité du stock / je nach Lagerverfügbarkeit / depending on stock availability

Tournage avant finition
 Vorwärts drehen schlichten
 Front turning for finishing

R

742SF-_/0

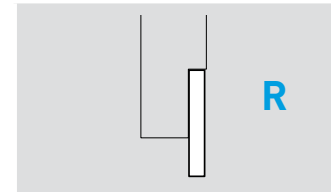
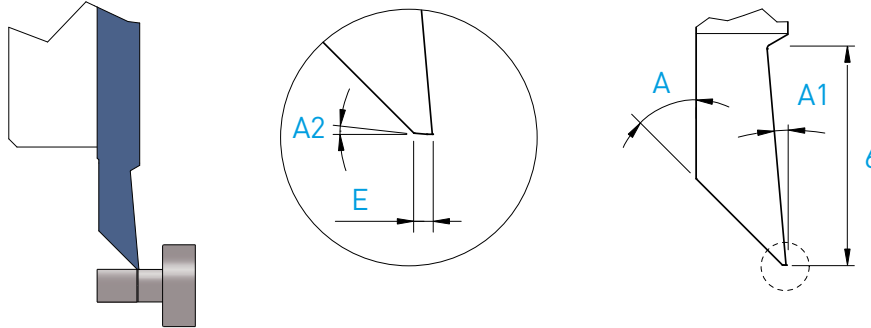

E	A	A1	A2	Art. N°	HTAF-RE	XTAF-RE
0.10	45°	5°	5°	742SF-10/0-5°-45°	■	■
0.15	30°	3°	2°	742SF-15/0-2°-30°	■	■

7XX-XX-B



Sur demande pour serrage type B, voir page 3
 Wahlweise für B-Spannsystem, siehe Seite 3
 On request for B clamping system, see page 3

Tournage avant
 Vorwärtsdrehen
 Front turning

R

742SF-X

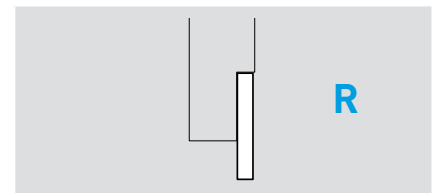
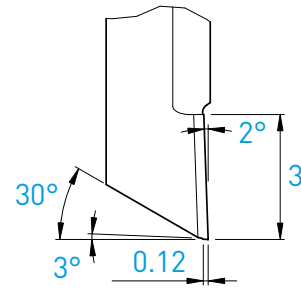
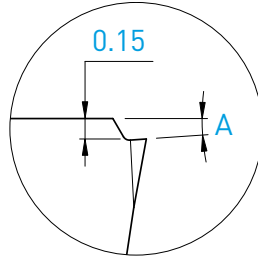
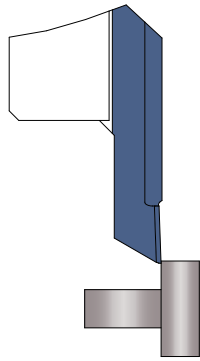

A	Art. N°	HTAXF	HCR-TF	HN (µK10)
4°	742SF-X412	■	■	■
8°	742SF-X812	■	■	■
12°	742SF-X1212	■	■	■



7XX-XX-B

Sur demande pour serrage type B, voir page 3
 Wahlweise für B-Spannsystem, siehe Seite 3
 On request for B clamping system, see page 3

■ = disponible / verfügbar / available
 □ = selon disponibilité du stock / je nach Lagerverfügbarkeit / depending on stock availability

Tournage arrière ébauche
 Rückwärts drehen schrappen
 Back turning for roughing

R

743SF

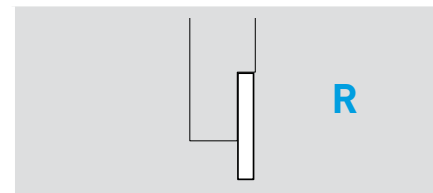
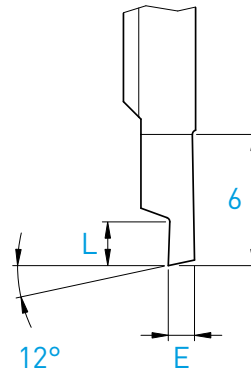
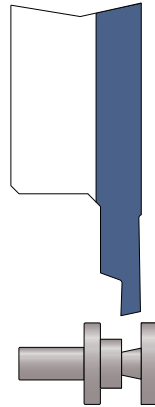

E	L	Art. N°	HTC	HTAF	HN (μK10)
1.2	2.5	743SF-120/0-12°	■	■	■
1.4	3.0	743SF-140/0-12°	■	■	■
1.6	3.0	743SF-160/0-12°	■	■	■
1.8	4.0	743SF-180/0-12°	■	■	■

7XX-XX-B



Sur demande pour serrage type B, voir page 3
 Wahlweise für B-Spannsystem, siehe Seite 3
 On request for B clamping system, see page 3

- Tournage arrière ébauche/ finition
- Rückwärts drehen schrumpfen/schlichten
- Back turning for roughing/finishing

R

743SF-3/3

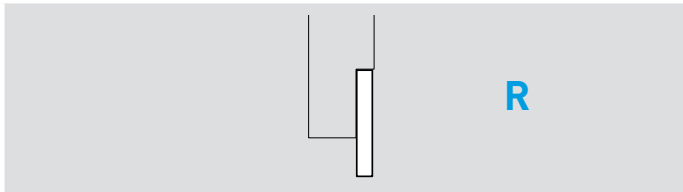
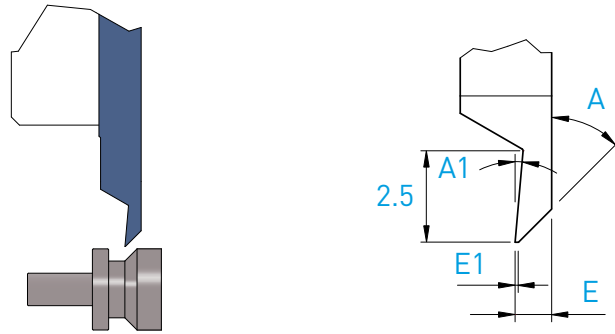

E1	E	A	A1	Art. N°	HTC	HTC-RE	HTAF	HTAF-RE	HTAXF	HTAXF-RE	HTiN	HN (µK10)	XTAF	XTAXF	XTAXF-RE	XN (µK01)
0.03	1.0	45°	5°	743SF-3/3-45°-1.0	■	■	■	■	■	■	□	■	■	■	■	■
0.03	1.2	45°	5°	743SF-3/3-45°-1.2	■	■	■	■	■	■	□	■	■	■	■	■
0.10	1.0	45°	5°	743SF-10/10-45°-1.0	■	■	■	■	■	■	□	■	■	■	■	■
0.05	0.8	30°	3°	743SF-5/5-30°-0.8				■								
0.05	1.0	30°	3°	743SF-5/5-30°-1.0				■								



7XX-XX-B

Sur demande pour serrage type B, voir page 3
 Wahlweise für B-Spannsystem, siehe Seite 3
 On request for B clamping system, see page 3

■ = disponible / verfügbar / available
 □ = selon disponibilité du stock / jenach Lagerverfügbarkeit / depending on stock availability

Tournage arrière finition
 Rückwärts drehen schlichten
 Back turning for finishing

R

743SF-10/3

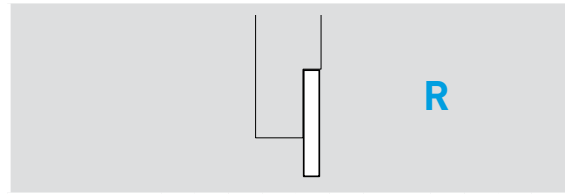
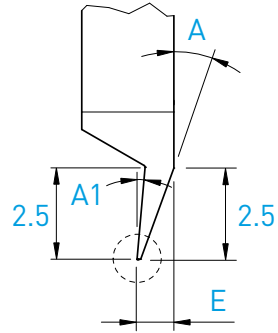
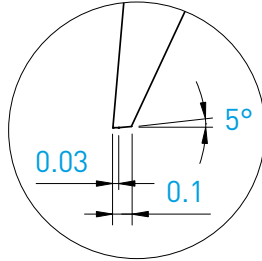
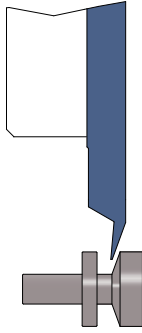

E	A	A1	Art. N°	HTC	HTC-RE	HTAF	HTAF-RE	HTAXF	HTAXF-RE	HTiN	HN (μK10)	XTAF	XTAXF	XTAXF-RE	XN (μK01)
1.0	20°	5°	743SF-10/3	■	■	■	■	■	■	□	■	■	■	□	□

7XX-XX-B



Sur demande pour serrage type B, voir page 3
 Wahlweise für B-Spannsystem, siehe Seite 3
 On request for B clamping system, see page 3

Tournage arrière finition
 Rückwärts drehen schlichten
 Back turning for finishing

R

743SF-_/0

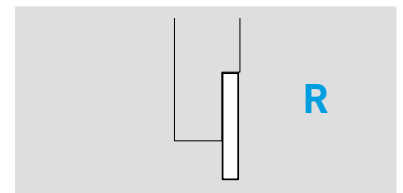
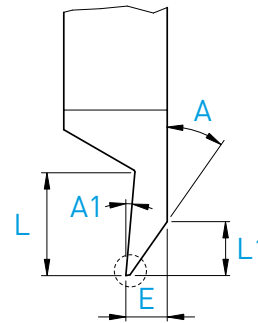
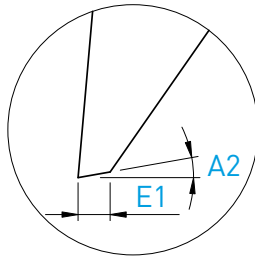
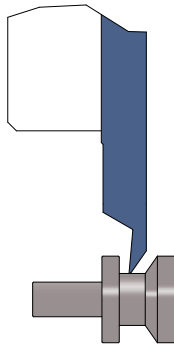

E1	E	L1	L	A	A1	A2	Art. N°	HTAF-RE	XTAF-RE
0.08	1.0	1.6	2.5	30°	5°	2°	743SF-8/0-2°-30°-1.0	■	■
0.15	1.2	1.8	4.0	30°	3°	2°	743SF-15/0-2°-30°-1.2	■	■
0.10	1.0	1.3	2.5	35°	5°	10°	743SF-10/0-10°-35°-1.0	■	■



7XX-XX-B

Sur demande pour serrage type B, voir page 3
 Wahlweise für B-Spannsystem, siehe Seite 3
 On request for B clamping system, see page 3

■ = disponible / verfügbar / available
 □ = selon disponibilité du stock / jenach Lagerverfügbarkeit / depending on stock availability

Tournage arrière
Rückwärts drehen
Back turning

R

743SF-X

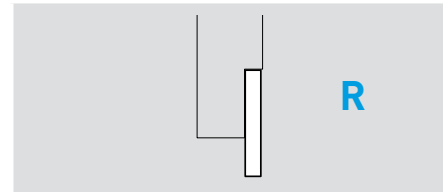
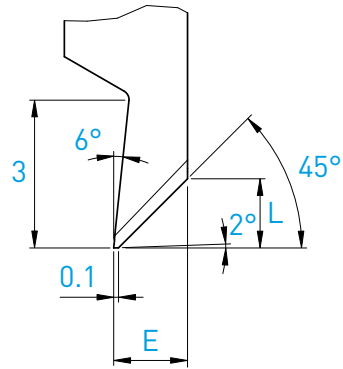
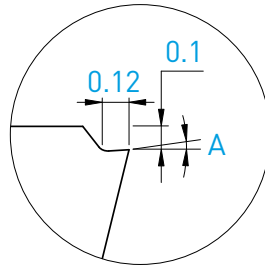
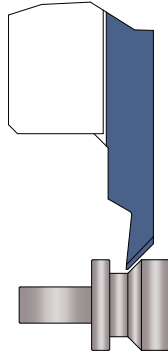

E	L	A	Art. N°	HTAXF	HCR-TF	HN (μK10)
1.0	0.9	4°	743SF-X412-45°-1.0	■	■	■
		8°	743SF-X812-45°-1.0	■	■	■
		12°	743SF-X1212-45°-1.0	■	■	■
1.5	1.4	4°	743SF-X412-45°-1.5	■	■	■
		8°	743SF-X812-45°-1.5	■	■	■
		12°	743SF-X1212-45°-1.5	■	■	■

7XX-XX-B

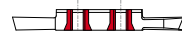

Sur demande pour serrage type B, voir page 3
Wahlweise für B-Spannsystem, siehe Seite 3
On request for B clamping system, see page 3

Fonçage-tournage

Einstecken und drehen

Grooving and turning

R

744SF-X

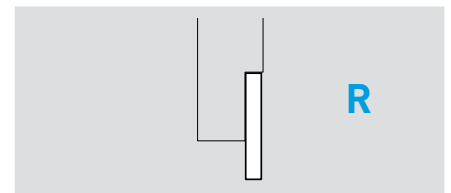
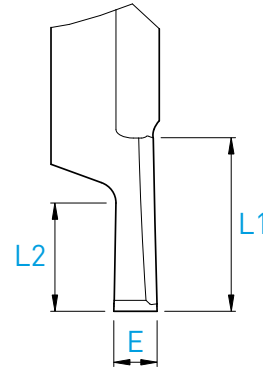
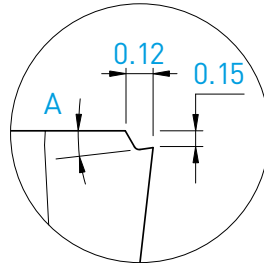
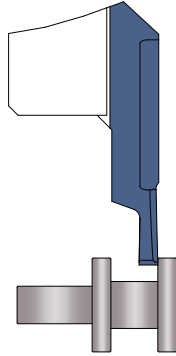

A	E	L1	L2	Art. N°	HTAXF	HCR-TF	HN (µK10)
4°	0.6	3	1.5	744SF-X412-0.6	■	■	■
	0.8	4	2.0	744SF-X412-0.8	■	■	■
	1.0	4	2.5	744SF-X412-1.0	■	■	■
	1.2	5	3.0	744SF-X412-1.2	■	■	■
8°	0.6	3	1.5	744SF-X812-0.6	■	■	■
	0.8	4	2.0	744SF-X812-0.8	■	■	■
	1.0	4	2.5	744SF-X812-1.0	■	■	■
	1.2	5	3.0	744SF-X812-1.2	■	■	■

7XX-XX-B



Sur demande pour serrage type B, voir page 3
Wahlweise für B-Spannsystem, siehe Seite 3
On request for B clamping system, see page 3

■ = disponible / verfügbar / available

□ = selon disponibilité du stock / jenach Lagerverfügbarkeit / depending on stock availability

Filetage à profil partiel – norme NIHS

Gewinde drehen mit Teilprofil – Norm NIHS

Threading with partial profile – norm NIHS

L

736SF

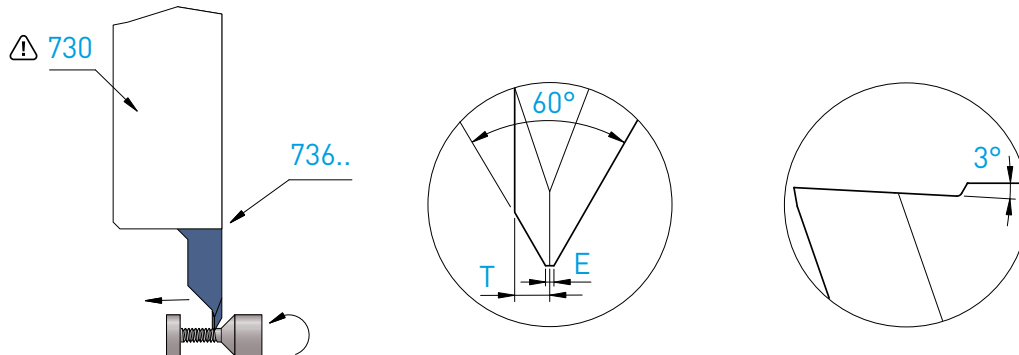

Filetage à droite
sens rotation machine M4

Rechtgewinde Drehrichtung
der Maschine M4

Right-hand thread rotating
machinery M4

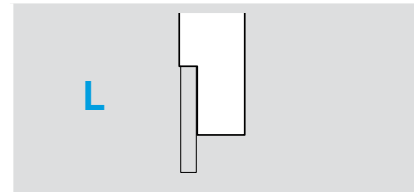

Filetage Gewinde drehen Threading	Pas Steigung Pitch P	T	E 0/-0.01	Art. N°	HTAF HN (µK10)
S0.50	0.125	0.07	0.015	736SFX3-A60-S0.50-AR	■ ■
S0.60	0.150	0.09	0.020	736SFX3-A60-S0.60-AR	■ ■
S0.70	0.175	0.10	0.020	736SFX3-A60-S0.70-AR	■ ■
S0.80	0.200	0.12	0.025	736SFX3-A60-S0.80-AR	■ ■
S0.90	0.225	0.13	0.030	736SFX3-A60-S0.90-AR	■ ■
S1.00	0.250	0.15	0.035	736SFX3-A60-S1.00-AR	■ ■

7XX-XX-B



Sur demande pour serrage type B, voir page 3
Wahlweise für B-Spannsystem, siehe Seite 3
On request for B clamping system, see page 3

Filetage à profil partiel – norme NIHS

Gewinde drehen mit Teilprofil – Norm NIHS

Threading with partial profile – norm NIHS

R

746SF

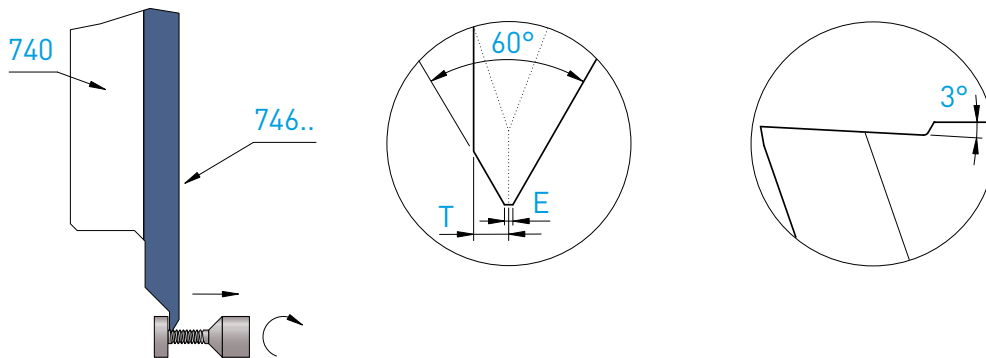

Filetage à droite
sens rotation machine M3

Rechtgewinde Drehrichtung
der Maschine M3

Right-hand thread rotating
machinery M3

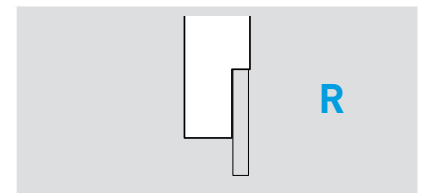

Filetage Gewinde drehen Threading	Pas Steigung Pitch P	T	E 0/-0.01	Art. N°	HTAF HN (µK10)
S0.50	0.125	0.07	0.015	746SFX3-A60-S0.50-AR	■ ■
S0.60	0.150	0.09	0.020	746SFX3-A60-S0.60-AR	■ ■
S0.70	0.175	0.10	0.020	746SFX3-A60-S0.70-AR	■ ■
S0.80	0.200	0.12	0.025	746SFX3-A60-S0.80-AR	■ ■
S0.90	0.225	0.13	0.030	746SFX3-A60-S0.90-AR	■ ■
S1.00	0.250	0.15	0.035	746SFX3-A60-S1.00-AR	■ ■

7XX-XX-B



Sur demande pour serrage type B, voir page 3
Wahlweise für B-Spannsystem, siehe Seite 3
On request for B clamping system, see page 3

■ = disponible / verfügbar / available

□ = selon disponibilité du stock / jenach Lagerverfügbarkeit / depending on stock availability

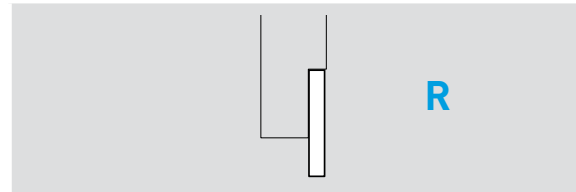
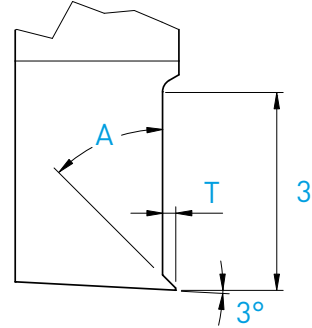
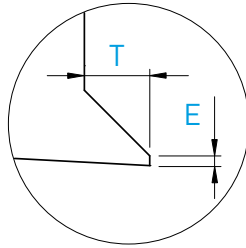
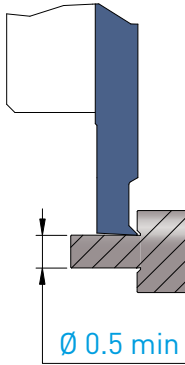

E 0/-0.01	A	T	Art. N°	HTC	HTC-RE	HTAF	HTAF-RE	HTiN	HN (µK10)
0.03	45°	0.2	748SF-E03-A45°-L20	■	■	■	■	□	■
0.05	45°	0.3	748SF-E05-A45°-L30	■	■	■		■	■
0.08	45°	0.5	748SF-E08-A45°-L50	■	■	■		□	■

7XX-XX-B



Sur demande pour serrage type B, voir page 3
 Wahlweise für B-Spannsystem, siehe Seite 3
 On request for B clamping system, see page 3

Plaquettes piqûre arrière
 Rückeinstich WSP
 Back grooving inserts

R

749SF

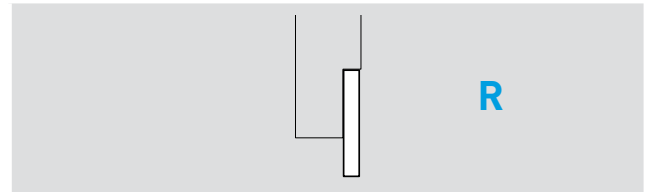
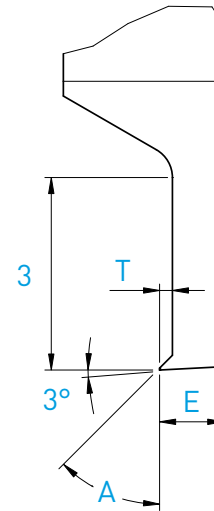
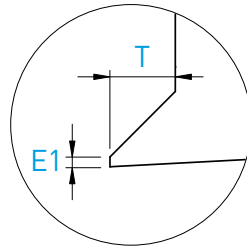
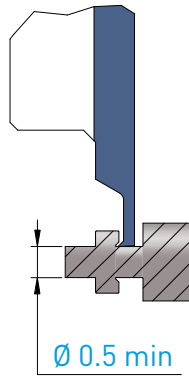

E1 0/-0.01	A	T	E	Art. N°	HTC	HTC-RE	HTAF	HTAF-RE	HTiN	HN (µK10)
0.03	45°	0.2	1.0	749SF-E03-A45°-L20-B100	■	■	■	■	□	■
0.05	45°	0.3	1.0	749SF-E05-A45°-L30-B100	■	□	■		□	■
0.08	45°	0.5	1.2	749SF-E08-A45°-L50-B120	■	■	■		□	■



7XX-XX-B

Sur demande pour serrage type B, voir page 3
 Wahlweise für B-Spannsystem, siehe Seite 3
 On request for B clamping system, see page 3

■ = disponible / verfügbar / available
 □ = selon disponibilité du stock / jenach Lagerverfügbarkeit / depending on stock availability

L

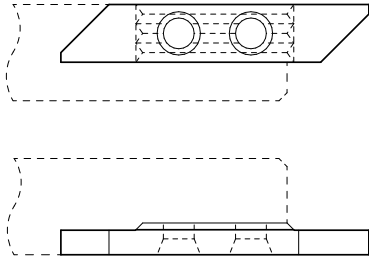

R

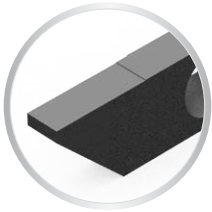
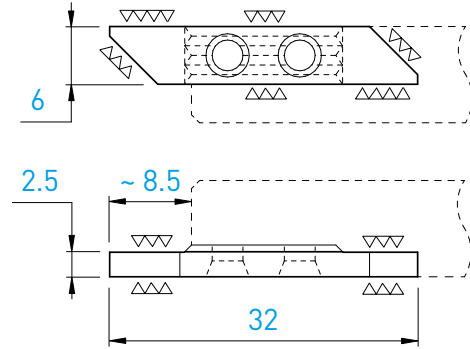

L										R									
Art. N°	HTC	HTAF	HTAXF	HCR-TF	HTiN	HN (μK10)	XTC	XTAF	XN (μK01)	Art. N°	HTC	HTAF	HTAXF	HCR-TF	HTiN	HN (μK10)	XTC	XTAF	XN (μK01)
731-ESF	■	■	■	■	■	■	■	■	■	741-ESF	■	■	■	■	■	■	■	■	■

7XX-XX-B



Sur demande pour serrage type B, voir page 3
Wahlweise für B-Spannsystem, siehe Seite 3
On request for B clamping system, see page 3

Porte-outils
 Halter
 Holders

Coupe à droite déportée
 Versetztes Rechtsschneiden
 Right cut off line

730RC

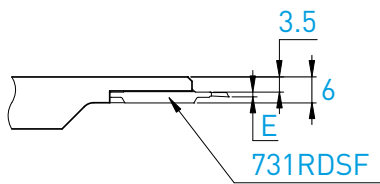
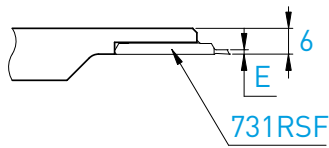
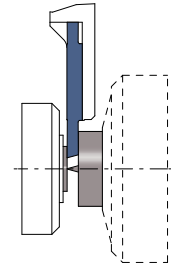
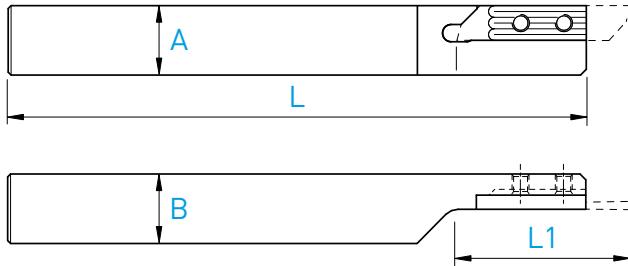

L (R)			Art. N°
A x B	L	L1	
8 x 8	115	24	730RC-8
10 x 10	115	24	730RC-10
12 x 12	130	30	730RC-12
12.7 x 12.7	130	30	730RC-12.7
16 x 16	130	40	730RC-16

Chaque support est livré avec vis et clé.
 Jeder Halter wird mit Spannschraube(n) und Schlüssel geliefert.
 Screw(s) and key are included with each tool holder.

Porte-outils Halter Holders	Serrage standard (A) Standard Spannsystem (A) Standard clamping system (A)
730RC	V-M3X5.5-T8 C-T8

Tronçonnage

Abstechen

Parting off

Coupe à droite déportée

Versetztes Rechtsschneiden

Right cut off line

L (R)

731RSF

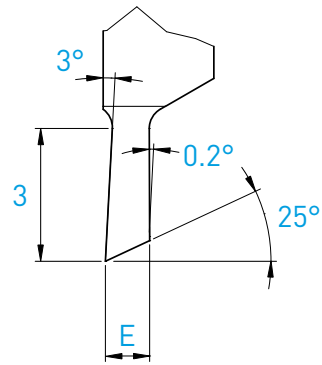
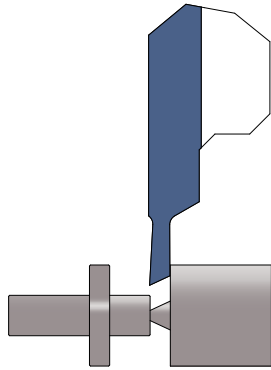

L (R)

Coupe à droite déportée
Versetzttes Rechtsschneiden
Right cut off line

E	Art. N°	HTAF	HTiN	HN (μK10)
1.0	731RSF-1.0-25°	■	■	■

Tronçonnage
Abstechen
Parting off

Coupe à droite déportée
Versetztes Rechtsschneiden
Right cut off line

L (R)

731RDSF

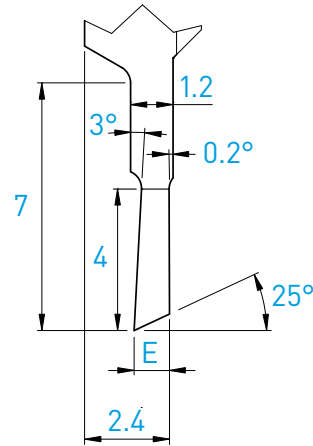
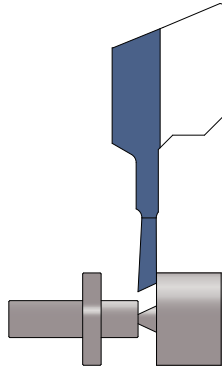

L (R)

Coupe à droite déportée
Versetztes Rechtsschneiden
Right cut off line

E	Art. N°	HTAF	HTiN	HN (µK10)
0.8	731RDSF-0.8-25°	■		■
1.0	731RDSF-1.0-25°	■	□	■

■ = disponible / verfügbar / available

□ = selon disponibilité du stock / jenach Lagerverfügbarkeit / depending on stock availability

Porte-outils

Halter

Holder

Coupe à droite déportée

Versetztes Rechtsschneiden

Right cut off line

750RC

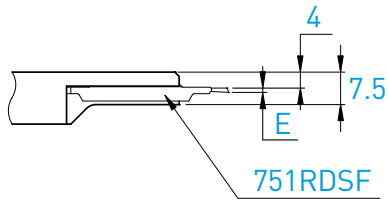
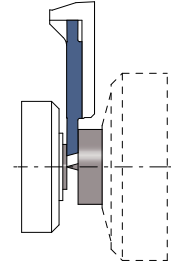
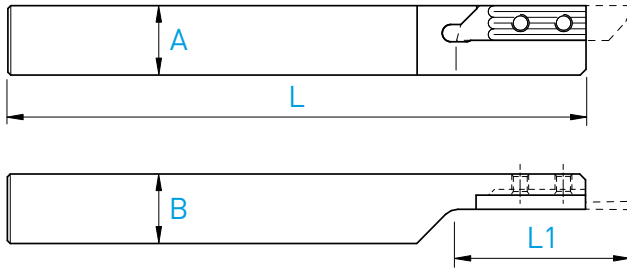

L (R) Coupe à droite déportée Versetztes Rechtsschneiden Right cut off line			
A x B	L	L1	Art. N°
12 x 12	130	30	750RC-12
16 x 16	130	40	750RC-16

Chaque support est livré avec vis et clé.
 Jeder Halter wird mit Spannschraube(n) und Schlüssel geliefert.
 Screw(s) and key are included with each tool holder.

Porte-outils Halter Holder	Serrage standard (A) Standard Spannsystem (A) Standard clamping system (A)
750RC	V-M4X7.3-T15 C-T15

Porte-outils
 Halter
 Holders

Coupe à droite déportée
 Versetztes Rechtsschneiden
 Right cut off line

L (R)

751RDSF

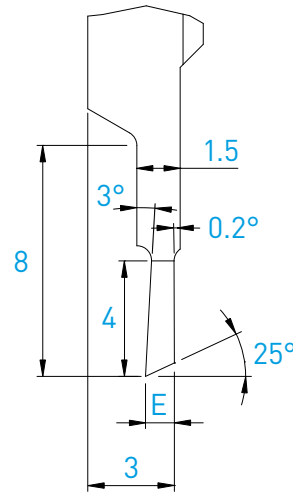
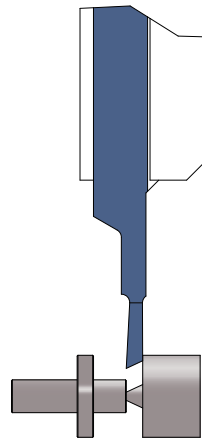

L (R)

Coupe à droite déportée
 Versetztes Rechtsschneiden
 Right cut off line

E	Art. N°	HTAF	HTiN	HN (µK10)
0.8	751RDSF-0.8-25°	■		■
1.0	751RDSF-1.0-25°	■	□	■

■ = disponible / verfügbar / available
 □ = selon disponibilité du stock / jenach Lagerverfügbarkeit / depending on stock availability

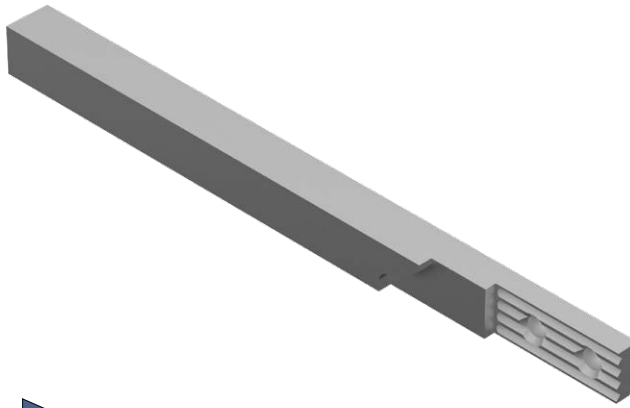
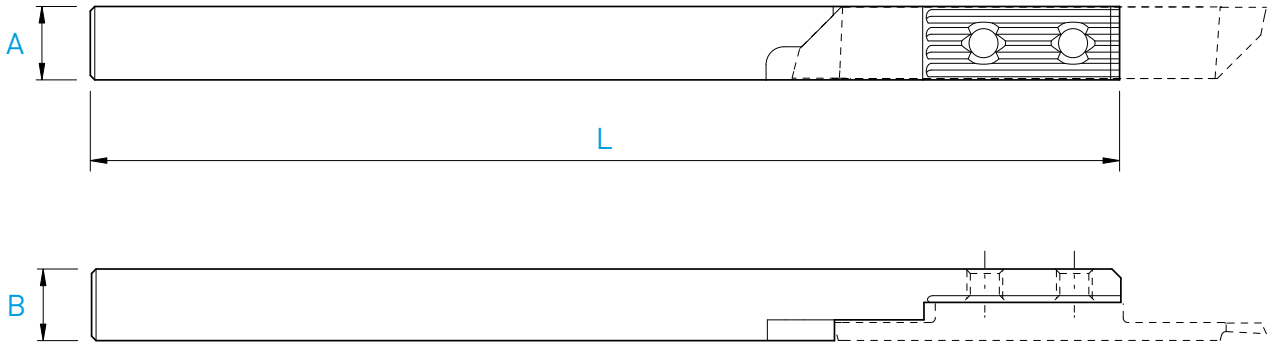

L (R)		
Coupe à droite déportée Versetzttes Rechtsschneiden Right cut off line		
A x B	L	Art. N°
8.2 x 8	115	770-8.2X8-SN4-SF

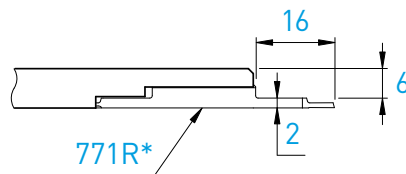
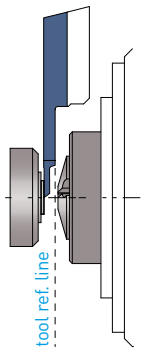
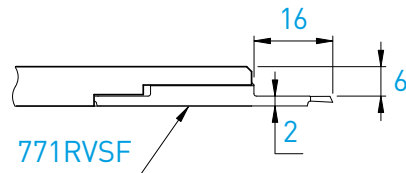
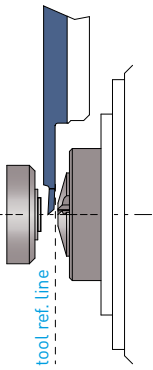

* voir TOP-Line
* siehe TOP-Line
* see TOP-Line

Porte-outils Halter Holder	Serrage standard (A) Standard Spannsystem (A) Standard clamping system (A)	
770-SN-SF	V-M4X7.3-T15	C-T15

Chaque support est livré avec vis et clé.
Jeder Halter wird mit Spannschraube(n) und Schlüssel geliefert.
Screw(s) and key are included with each tool holder.

Porte-outils
 Halter
 Holders

SwissNANO 7

770-SN7-SF

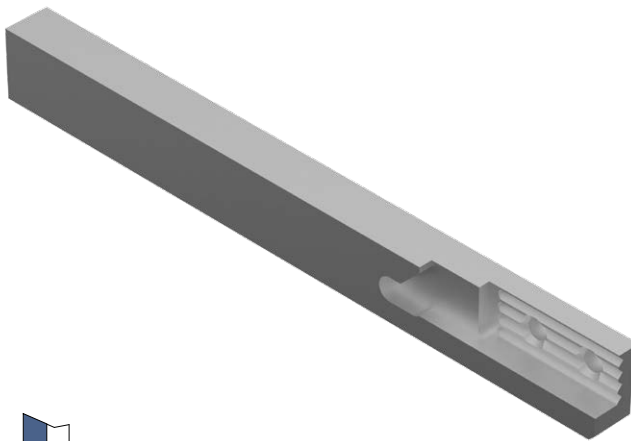
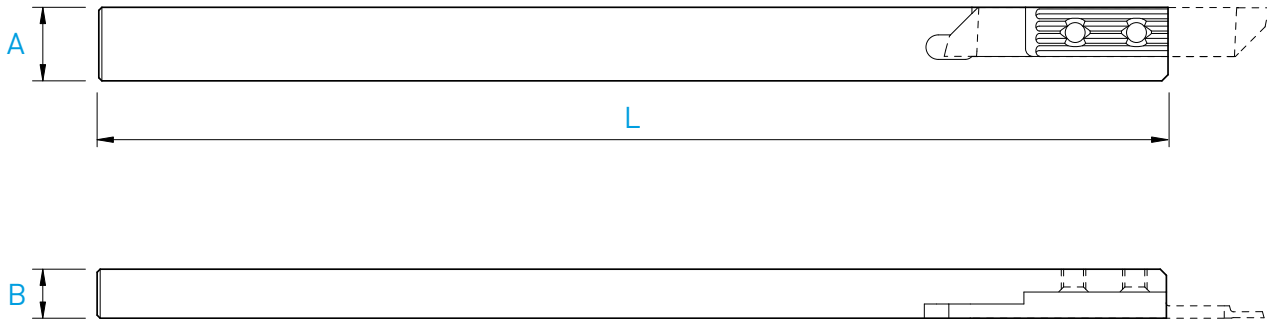

L (R)		
Coupe à droite déportée Versetztes Rechtsschneiden Right cut off line		
A x B	L	Art. N°
12 x 8	115	770-12X8-SN7-SF

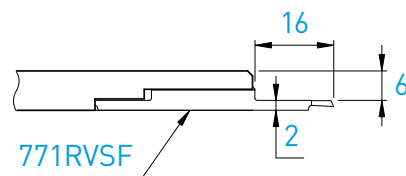
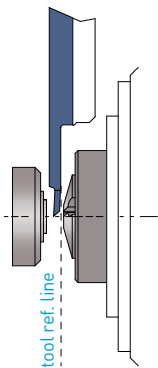

771RVSF

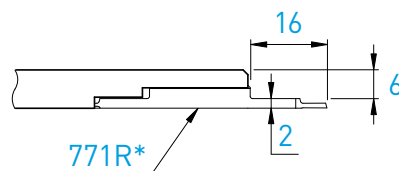
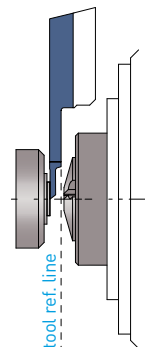

771R*

* voir TOP-Line
 * siehe TOP-Line
 * see TOP-Line

Porte-outils Halter Holders	Serrage standard (A) Standard Spannsystem (A) Standard clamping system (A)
770-SN-SF	
V-M4X7.3-T15	C-T15

Chaque support est livré avec vis et clé.
 Jeder Halter wird mit Spannschraube(n) und Schlüssel geliefert.
 Screw(s) and key are included with each tool holder.

Plaquette
Wendepatte
Insert

Coupe à droite déportée
Versetztes Rechtsschneiden
Right cut off line

L (R)

771RVSF

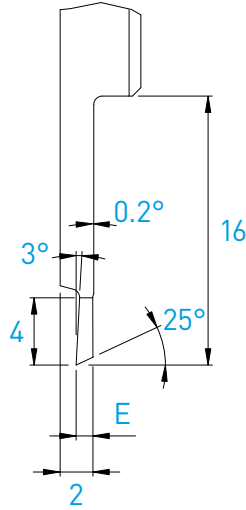
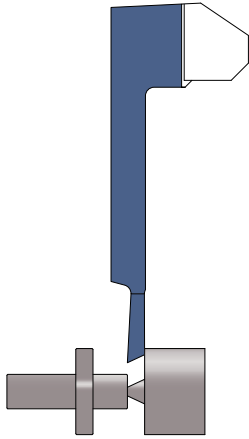

L (R)

Coupe à droite déportée
Versetztes Rechtsschneiden
Right cut off line

E	Art. N°	TAF	N (μK20)
1.0	771RVSF-1.0-25°	■	■
1.2	771RVSF-1.2-25°	■	■
1.5	771RVSF-1.5-25°	■	■

Porte-outils spéciaux de tronçonnage
Sonder Abstechwerkzeughalter
Special parting off tool holders

MODU-LINE

ML12

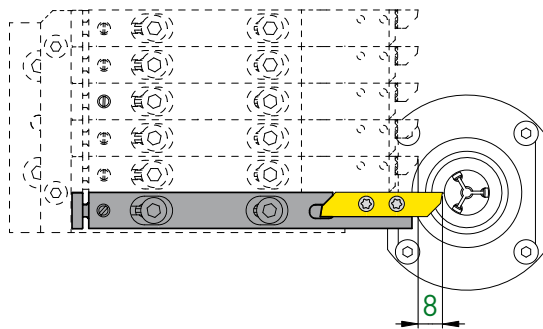

Type de machine Maschinen-Typ Type of machine	Porte-outils Halter Holders	Art. N°	Plaquettes type WSP Typ Inserts type
SwissNano	ML12	ML12A-730RC-SWISS-NANO	731RSF / 731RDSF
SwissNano	ML12	ML12A-750RC-SWISS-NANO	751RDSF

Voir documentation MODU-Line
Siehe MODU-Line Dokumentation
See MODU-Line documentation

**OUTILS DE HAUTES PERFORMANCES
POUR LE DÉCOLLETAGE
ET LA MICROMÉCANIQUE**

**HOCHLEISTUNGSWERKZEUGE
FÜR DREHAUTOMATEN
UND MIKROMECHANIK**

**HIGH PERFORMANCE TOOLING
FOR AUTOMATIC LATHES
AND MICROMECHANICS**



PERFORMANCE | PRECISION | RIGIDITY



WATCH

**APPLITEC MOUTIER SA
RUE INDUSTRIELLE 95
2740 MOUTIER
CH-SWITZERLAND**

**+41 (0)32 494 60 20
INFO@APPLITEC-TOOLS.COM**

WWW.APPLITEC-TOOLS.COM